



Micro Component Audio System

Model Name : MM-G25

Model Code : MM-G25T/XAP

SERVICE Manual

Micro Component Audio System

CONTENTS

1. Precaution
2. Product Specification
3. Disassembly & Reassembly
4. Troubleshooting
5. Exploded View & Part List
6. PCB Diagram
7. Schematic Diagram



MM-G25

Refer to the service manual in the GSPN (see the rear cover) for the more information.



GSPN (Global Service Partner Network)

Area	Web Site
North America	service.samsungportal.com
Latin America	latin.samsungportal.com
CIS	cis.samsungportal.com
Europe	europe.samsungportal.com
China	china.samsungportal.com
Asia	asia.samsungportal.com
Mideast & Africa	mea.samsungportal.com

This Service Manual is a property of Samsung Electronics Co.,Ltd. Any unauthorized use of Manual can be punished under applicable International and/or domestic law.

© Samsung Electronics Co.,Ltd. **Apr. 2009**
Printed in Korea

Contents

1. Precaution

1-1 Safety Precautions	1-1
1-2 Servicing Precautions	1-3
1-3 Precautions for Electrostatically Sensitive Devices (ESDs)	1-4

2. Product Specification

2-1 Product Feature	2-1
2-2 Specifications	2-2
2-3 Specifications Analysis	2-4
2-4 Accessories	2-5

3. Disassembly & Reassembly

3-1 Overall Disassembly & Reassembly	3-1
--	-----

4. Troubleshooting

4-1 Checkpoints by Error Mode	4-2
4-2 MICOM, MPEG Initialization & Update	4-11
4-3 Buyer-Region Code Setting Method	4-12

5. Exploded View & Part List

5-1 Exploded View	5-2
5-2 Speaker System	5-4
5-3 Electrical Part List	5-5

6. PCB Diagram

6-1 Wiring Diagram	6-2
6-2 FRONT PCB Top	6-3
6-3 FRONT PCB Bottom	6-5
6-4 TAPE PCB Top	6-6
6-5 TAPE PCB Bottom	6-8
6-6 MAIN PCB Top	6-9
6-7 MAIN PCB Bottom	6-12
6-8 MPEG PCB Top	6-14
6-9 MPEG PCB Bottom	6-17

Contents

7. Schematic Diagram

7-1 Overall Block Diagram	7-2
7-2 FRONT	7-3
7-3 TAPE	7-4
7-4 MAIN	7-5
7-5 MPEG.....	7-6
7-6 SMPS.....	7-7

2. Product Specification

2-1 Product Feature

2-1-1 MM-DG25 Product Feature

- **120W Power**
- **2 CH**
 - Powerful Sound Experience
- **DVD**
- **USB Host w/ video playback**
- **Tuner**
- **Various Multimedia Playback**
 - DIVX, MP3, WMA, Photo Files

2-1-2 MM-G25 Product Feature

- **120W Power**
- **2 CH**
 - Powerful Sound Experience
- **CD RIPPING**
- **USB Host w/ video playback**
- **Tuner**
- **Various Multimedia Playback**
 - MP3, WMA

2-2 Specifications

2-2-1 MM-DG25 Specifications

■ Basic Specification



RADIO FM	Signal/noise ratio	62 dB
	Usable sensitivity	10 dB
	Total harmonic distortion	0.4 %
COMPACT DISC PLAYER	Capacity	1 disc
	Frequency range	20 Hz - 20 KHz (\pm 1 dB)
	Signal/noise ratio	90 dB (at 1 KHz) with filter
	Distortion	0.1 % (at 1 KHz)
	Channel separation	75 dB
	Disc sizes	Diameter: 120 or 80 mm. Thickness: 1.2 mm
AMPLIFIER	Output power Front Speaker (4Ω)	60 Watts/CH RMS, IEC (total harmonic distortion: 10 %)
	Channel separation	60 dB
	Signal/noise ratio	70 dB
GENERAL	Power Consumption	35W
	Dimensions	230 (D) x 154 (H) x 251 (W) mm
	Weight	2.2 Kg

2-2-2 MM-G25 Specifications

■ Basic Specification

RADIO FM	Signal/noise ratio	62 dB
	Usable sensitivity	10 dB
	Total harmonic distortion	0.4 %
COMPACT DISC PLAYER	Capacity	1 disc
	Frequency range	20 Hz - 20 KHz (\pm 1 dB)
	Signal/noise ratio	90 dB (at 1 KHz) with filter
	Distortion	0.1 % (at 1 KHz)
	Channel separation	75 dB
	Disc sizes	Diameter: 120 or 80 mm. Thickness: 1.2 mm
AMPLIFIER	Output power Front Speaker (4Ω)	60 Watts/CH RMS, IEC (total harmonic distortion: 10 %)
	Channel separation	60 dB
	Signal/noise ratio	70 dB
GENERAL	Power Consumption	35W
	Dimensions	230 (D) x 154 (H) x 251 (W) mm
	Weight	2.2 Kg



2-3 Specifications Analysis

Model Name	MM-DG25	MM-G25	MM-DA25
Photo			
OUTPUT POWER	120W	120W	50 x 2
FRONT DISPLAY	VFD	VFD	VFD
SLEEP	○	○	○
DIMMER	○	○	○
CD/DVD	CD/DVD	CD	CD/DVD
MP3	○	○	○
USB HOST	VIDEO	VIDEO	○
CD RIPPING	○	○	X
EQ/DSP	○	○	X
AUDIO IN	○	○	○
HEAD JACK/MIC	○	○	○
AM	X	X	X
FM	○	○	○
RDS	○	○	○
TUNER MEMORY	20	20	20
REMOTE KEY	60 Key	37 Key	60 Key
UNIVERSAL	○	○	○
DUAL VOLTAGE	○	○	○
SPK IMPEDANCE	4Ω	4Ω	4Ω

※ ○: application, X: non-application

2-4 Accessories

2-4-1 Supplied Accessories

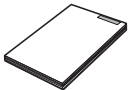
Accessories	Item	Item code	Remark
	Remote Control	AH59-02147C	Samsung Service Center
	FM Antenna	AH39-00320C	
	User's Manual	AH68-02157L AH68-02157Z	

MEMO

1. Precaution

Follow these safety, servicing and ESD precautions to prevent damage and protect against potential hazards such as electrical shock and X-rays.

1-1 Safety Precautions

1. Be sure that all of the built-in protective devices are replaced.
2. When reinstalling the chassis and its assemblies, be sure to restore all protective devices, including control knobs and compartment covers.
3. Make sure that there are no cabinet openings through which people--particularly children--might insert fingers and contact dangerous voltages. Such openings include the spacing between the picture tube and the cabinet mask, excessively wide cabinet ventilation slots, and improperly fitted back covers.
4. Design Alteration Warning:
Never alter or add to the mechanical or electrical design of the unit.
Example: Do not add auxiliary audio or video connectors. Such alterations might create a safety hazard.
Also, any design changes or additions will void the manufacturer's warranty.

5. Leakage Current Hot Check (Fig. 1-1):

Warning: Do not use an isolation transformer during this test. Use a leakage-current tester or a metering system that complies with American National Standards Institute (ANSI C101.1, Leakage Current for Appliances), and Underwriters Laboratories (UL Publication UL1410, 59.7).

With the unit completely reassembled, plug the AC line cord directly into a 120V AC outlet. With the unit's AC switch first in the ON position and then OFF, measure the current between a known earth ground (metal water pipe, etc.) and all exposed metal parts. Examples:

Handle brackets, metal cabinets, screwheads and control shafts. The current measured should not exceed 0.5 milliamp. Reverse the powerplug prongs in the AC outlet and repeat.

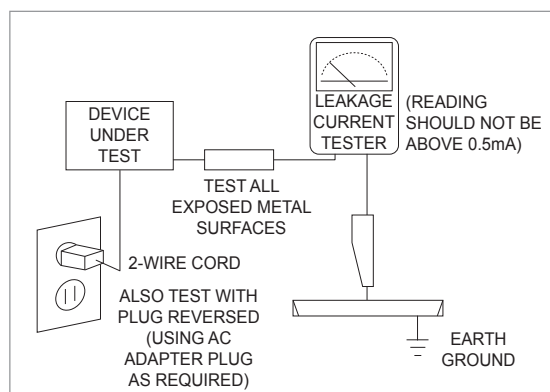

<Fig. 1-1 AC Leakage Test>

6. Insulation Resistance Cold Check:

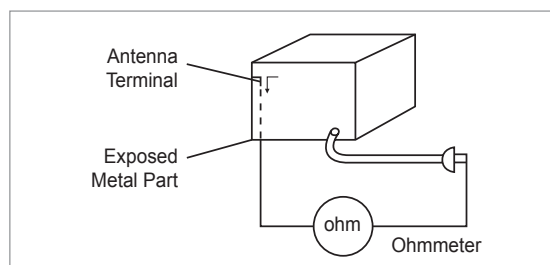

(1) With the unit's AC plug disconnected from the AC source, connect an electrical jumper across the two AC prongs. (2) Set the power switch to ON. (3) Measure the resistance between the shorted AC plug and any exposed metallic parts.

Example: Screwheads, antenna, control shafts or handle brackets.



<Fig. 1-2 Insulation Resistance Test>

If any of the exposed metallic parts has a return path to the chassis, the measured resistance should be between 1 and 5.2 megohms. If there is no return path, the measured resistance should be "infinite." If the resistance is outside these limits, a shock hazard might exist. See Fig. 1-2.

7. Components, parts and wiring that appear to have overheated or that are otherwise damaged should be replaced with parts that meet the original specifications. Always determine the cause of damage or overheating, and correct any potential hazards.
8. Observe the original lead dress, especially near the following areas: Antenna wiring, sharp edges, and especially the AC and high voltage power supplies. Always inspect for pinched, out-of-place, or frayed wiring. Do not change the spacing between components and the printed circuit board. Check the AC power cord for damage. Make sure that no wires or components touch thermally hot parts.
9. Product Safety Notice:
Some electrical and mechanical parts have special safety-related characteristics which might not be obvious from visual inspection. These safety features and the protection they give might be lost if the replacement component differs from the original—even if the replacement is rated for higher voltage, wattage, etc.
10. Components that are critical for safety are indicated in the circuit diagram by shading,  or . Use replacement components that have the same ratings, especially for flame resistance and dielectric strength specifications. A replacement part that does not have the same safety characteristics as the original might create shock, fire or other hazards.

1-2 Servicing Precautions

1. Servicing precautions are printed on the cabinet. Follow them.
2. Always unplug the unit's AC power cord from the AC power source before attempting to: (a) Remove or reinstall any component or assembly, (b) Disconnect an electrical plug or connector, (c) Connect a test component in parallel with an electrolytic capacitor.
3. Some components are raised above the printed circuit board for safety. An insulation tube or tape is sometimes used. The internal wiring may be clamped to prevent contact with thermally hot components. Reinstall all such elements to their original position.
4. After servicing, always check that the screws, components and wiring have been correctly reinstalled. Make sure that the portion around the serviced part has not been damaged.
5. Check the insulation between the blades of the AC plug and accessible conductive parts (examples: metal panels, input terminals and earphone jacks).
6. Insulation Checking Procedure: Disconnect the power cord from the AC source and turn the power switch ON. Connect an insulation resistance meter (500V) to the blades of the AC plug.

The insulation resistance between each blade of the AC plug and accessible conductive parts (see above) should be greater than 1 megohm.

7. Never defeat any of the B+ voltage interlocks. Do not apply AC power to the unit (or any of its assemblies) unless all solid-state heat sinks are correctly installed.
8. Always connect a test instrument's ground lead to the instrument chassis ground before connecting the positive lead; always remove the instrument's ground lead last.



First read the "Safety Precautions" section of this manual. If some unforeseen circumstance creates a conflict between the servicing and safety precautions, always follow the safety precautions.

1-3 Precautions for Electrostatically Sensitive Devices (ESDs)

1. Some semiconductor (“solid state”) devices are easily damaged by static electricity. Such components are called Electrostatically Sensitive Devices (ESDs). Examples include integrated circuits and some field-effect transistors. The following techniques will reduce the occurrence of component damage caused by static electricity.
2. Immediately before handling any semiconductor components or assemblies, drain the electrostatic charge from your body by touching a known earth ground. Alternatively, wear a discharging wrist-strap device. (Be sure to remove it prior to applying power--this is an electric shock precaution.)
3. After removing an ESD-equipped assembly, place it on a conductive surface such as aluminum foil to prevent accumulation of electrostatic charge.
4. Do not use freon-propelled chemicals. These can generate electrical charges that damage ESDs.
5. Use only a grounded-tip soldering iron when soldering or unsoldering ESDs.
6. Use only an anti-static solder removal device. Many solder removal devices are not rated as “anti-static” (these can accumulate sufficient electrical charge to damage ESDs).
7. Do not remove a replacement ESD from its protective package until you are ready to install it. Most replacement ESDs are packaged with leads that are electrically shorted together by conductive foam, aluminum foil or other conductive materials.
8. Immediately before removing the protective material from the leads of a replacement ESD, touch the protective material to the chassis or circuit assembly into which the device will be installed.
9. Minimize body motions when handling unpackaged replacement ESDs. Motions such as brushing clothes together, or lifting a foot from a carpeted floor can generate enough static electricity to damage an ESD.

5. Exploded View & Part List

5-1	Exploded View	5-2
5-2	Speaker System.....	5-4
5-3	Electrical Part List.....	5-5

5-1 Exploded View

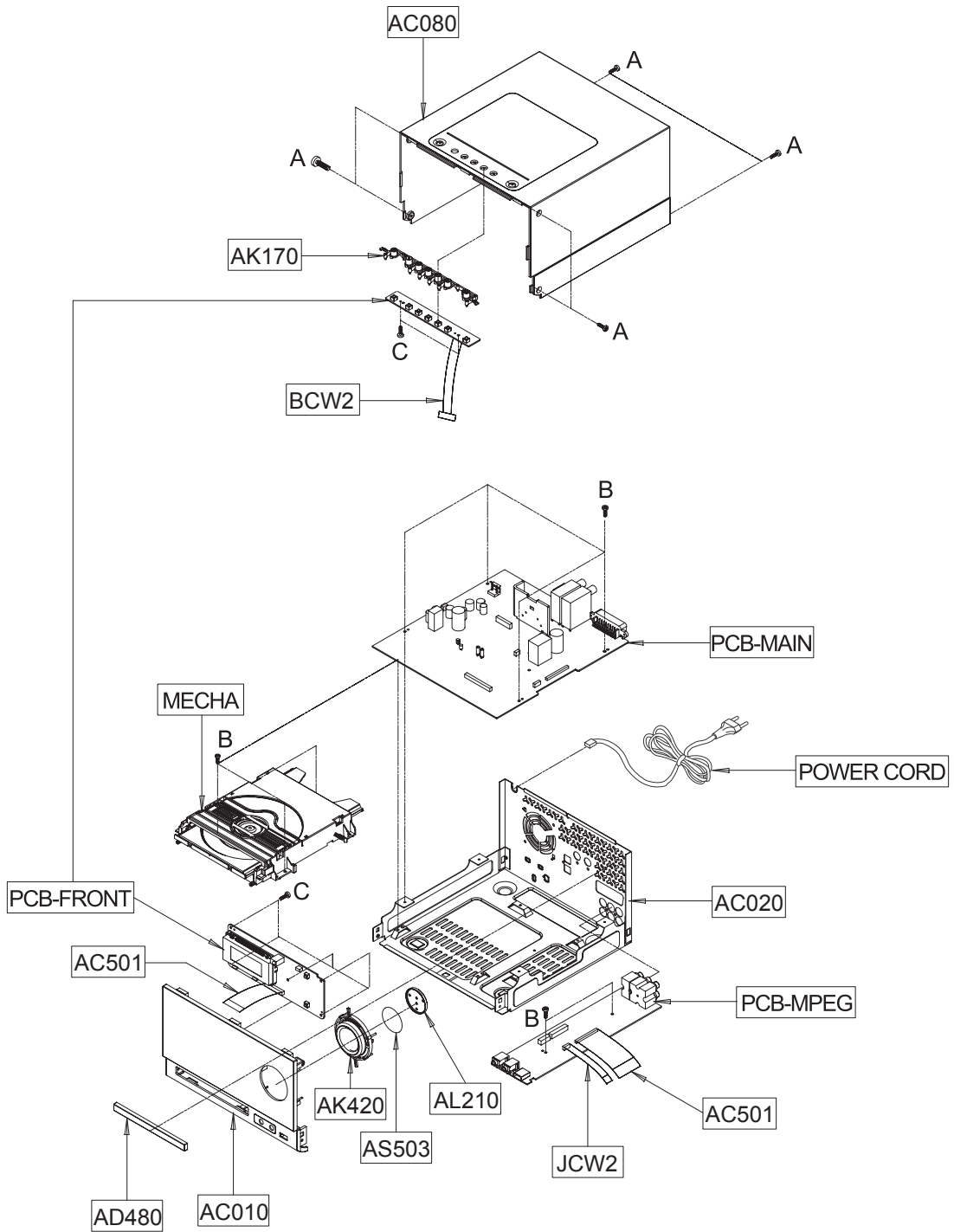

■ Part List

Loc. No.	Part No.	Description;Specification	Q'ty	SNA	Remark
AC010	AH64-05041C	CABINET FRONT;MM-DG25,ABS+PMMA,120,150,2	1	SA	
AC020	AH64-05043E	CABINET-BOTTOM;MM-DG25,SECC,T0.8,222,230	1	SA	
AC080	AH64-05042C	CABINET-TOP 1;MM-DG25,HIPS,106.4,229.4,2	1	SA	
AC501	3809-001434	CABLE-FLAT;30V,80C,100MM,12P,1.25MM,UL28	1	SA	
AC501	3809-002301	CABLE-FLAT;30V,80C,100mm,27P,1.25mm,UL28	1	SA	
AD480	AH64-05047C	DOOR-CD;MM-DG25,ABS,2,5.3,9.8,124,BLK,	1	SA	
AK170	AH64-05045A	KNOB-FUNCTION;MM-DG25,ABS+PMMA,2,14.5,16	1	SA	
AK420	AH64-05044A	KNOB-VOLUME;MM-DG25,ABS+PMMA,2,60,22.5,B	1	SA	
AL210	AH67-00542A	LENS-VOLUME;MM-DG25,ABS,WHITE,34.5,2.9,M	1	SA	
AS503	AH63-01946A	SHEET-LENS;MM-G25,PET,0.05,31,31,BLACK	1	SA	
BCW2	AH39-20008M	LEAD CONNECTOR ASSY;5264,5395,2P,150MM,1	1	SA	
JCW2	AH39-00291A	LEAD CONNECTOR ASSY;RCA300,1007#26,6P,15	1	SA	
MECHA	AH96-00010A	ASSY DECK;MAX-DG89,WITH DOOR,CABLE R BEN	1	SA	
PCB-FRONT	AH92-03027A	ASSY PCB FRONT;MINI-DVD/CD,MM-DG25,ASSY	1	SA	
PCB-MAIN	AH92-03026C	ASSY PCB MAIN;MINI-DVD,MM-DG25,South Ame	1	SA	
PCB-MPEG	AH92-03015A	ASSY PCB DECK;MPEG,MAX-G25,DVD,-	1	SA	
POWER CORD	AC39-10200N	CBF-POWER CORD;AT,US,EP2/Y,HOUSING(2P),1	1	SA	
A	6003-000275	SCREW-TAPTYPE;BH,+,-,B,M3,L10,ZPC(BLK),S	12	SA	
B	6003-001375	SCREW-TAPTYPE;BH,+,-,B,M3,L8,ZPC(WHT),SW	17	SA	
C	6003-001464	SCREW-TAPTYPE;BH,+,-,B,M3,L10,ZPC(WHT)	8	SA	

5-2 Speaker System

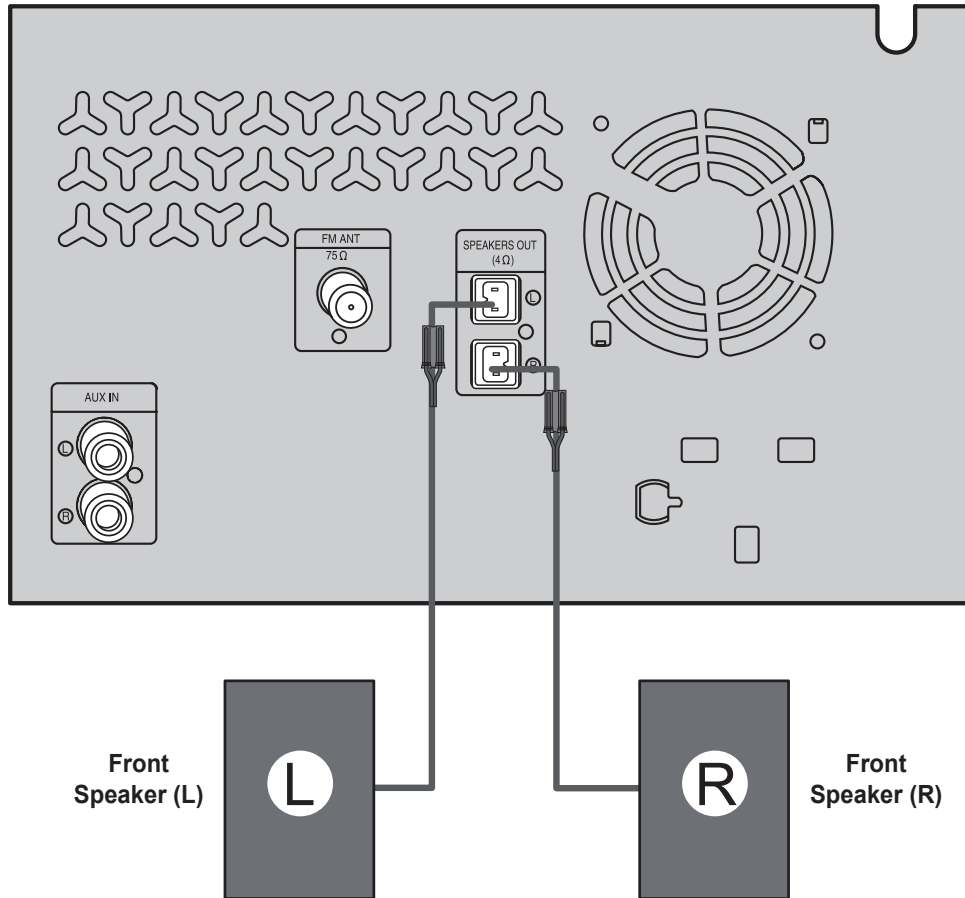

■ Part List

Loc. No.	Code No.	Description;Specification	Q'ty	SNA	Remark
Front Speaker (L/R)	AH59-02136E	SPEAKER SYSTEM-RCL;PS-G25,RCL,2.0CH	1	SA	

5-3 Electrical Part List

Loc. No.	Part No.	Description;Specification	Q'ty	SNA	Remark	Loc. No.	Part No.	Description;Specification	Q'ty	SNA	Remark
	AH59-02136E	SPEAKER SYSTEM-RCL;PS-G25,RCL,2.0CH	1	SNA		C8	2203-005148	C-CER,CHIP;100nF,10%,16V,X7R,TP,160	1	SA	
	AH64-05142A	PANEL FRONT;PS-G25,ABS,BLACK HIGH G	2	SNA		C9	2203-005148	C-CER,CHIP;100nF,10%,16V,X7R,TP,160	1	SA	
	AH81-04723D	A/S PART-CORE WIRE;PS-DG25,-,CORE	2	SA		CN12	3708-001616	CONNECTOR-FPC/FFC/PIC;9P,1mm,STRAIG	1	SA	
	AH81-04723F	A/S PART-FOOT;PS-DG25,-,FOOT,-,	8	SA		DAC1	2203-005148	C-CER,CHIP;100nF,10%,16V,X7R,TP,160	1	SA	
	AH81-04723J	A/S PART-WOOFER UNIT;PS-G25,WOOFER	2	SA		DAC10	2203-001607	C-CER,CHIP;0.22nF,5%,50V,NP0,1608	1	SA	
	AH81-04723L	A/S PART-CABINET;PS-DG25,WOOD,CABIN	2	SA		DAC11	2401-000918	C-AL;22uF,20%,16V,GP,-,6.3x7,5	1	SA	
	AH81-04723P	A/S PART-CUSHION;PS-G25,EPS,CUSHION	1	SA		DAC12	2401-000918	C-AL;22uF,20%,16V,GP,-,6.3x7,5	1	SA	
	AH81-05179A	A/S PART-GRILL W/F;PS-G25,STEEL,-,G	2	SA		DAC13	2401-000042	C-AL;100uF,20%,16V,GP,TP,6.3x7,5	1	SA	
						DAC14	2203-005148	C-CER,CHIP;100nF,10%,16V,X7R,TP,160	1	SA	
	AH59-02147C	REMOCON-ASSY;MM-G25-XAA,SAMSUNG,173	1	SA		DAC15	2203-005148	C-CER,CHIP;100nF,10%,16V,X7R,TP,160	1	SA	
	AH83-00005B	CKD-CASE-TOP;VR9038,ABS LG121	1	SNA		DAC16	2401-000042	C-AL;100uF,20%,16V,GP,TP,6.3x7,5	1	SA	
	AH83-00006A	CKD-CASE-BOTTOM;VR9038,ABS LG121	1	SNA		DAC2	2203-006361	C-CER,CHIP;10000nF,10%,10V,X5R,TP,2	1	SA	
	AH83-00007B	CKD-RUBBER-KEY;VR9038,SILICONE-REBB	1	SNA		DAC3	2203-005148	C-CER,CHIP;100nF,10%,16V,X7R,TP,160	1	SA	
	AH83-00008A	CKD-SPRING-REMOCON(+);VR9038,SUS 30	1	SNA		DAC5	2401-000414	C-AL;10uF,20%,16V,GP,TP,4x7,5	1	SA	
	AH83-00009A	CKD-SPRING-REMOCON(-);VR9038,SUS 30	1	SNA		DAC6	2401-000414	C-AL;10uF,20%,16V,GP,TP,4x7,5	1	SA	
	AH83-00010A	CKD-SPRING-REMOCON(C);VR9038,SUS 30	1	SNA		DAC7	2203-000888	C-CER,CHIP;4.7nF,10%,50V,X7R,TP,160	1	SA	
	AH83-00011A	CKD-E PASSED-LABEL;VR9038,40*10mm	1	SNA		DAC8	2203-000888	C-CER,CHIP;4.7nF,10%,50V,X7R,TP,160	1	SA	
	AH83-00012A	CKD-PE-BAG;VR9038,70*265mm	1	SNA		DAC9	2203-001607	C-CER,CHIP;0.22nF,5%,50V,NP0,1608	1	SA	
	AH83-00013A	CKD-PASSED-LABEL;VR9038,26*10mm	1	SNA		DAIC1	1002-001294	IC-D/A CONVERTER;PCM1742KE,24BIT,TS	1	SA	
	AH83-00014A	CKD-PCB-REMOCON;VR9038,KB-1150 T1.6	1	SNA		DAIC2	1201-000163	IC-OP AMP;4560,SOP,8P,173MIL,DUAL,1	1	SA	
	AH83-00015A	CKD-R-CHIP;VR9038,1ohm	1	SNA		DAL1	3301-001495	BEAD-SMD;120ohm,2012,2500mA,TP,115o	1	SA	
	AH83-00016A	CKD-C-ELEC;VR9038,47uF,16V	1	SNA		DAL2	3301-001495	BEAD-SMD;120ohm,2012,2500mA,TP,115o	1	SA	
	AH83-00017A	CKD-C-CHIP;VR9038,Y104	1	SNA		DAR1	2007-000113	R-CHIP;33ohm,5%,1/10W,TP,1608	1	SA	
	AH83-00018A	CKD-LED-IR;VR9038,LA503F1CR-1A-02,S	1	SNA		DAR10	2007-000097	R-CHIP;47Kohm,5%,1/10W,TP,1608	1	SA	
	AH83-00019B	CKD-IC-MCU;VR9038,ADAM26P20S	1	SNA		DAR11	2007-000097	R-CHIP;47Kohm,5%,1/10W,TP,1608	1	SA	
	AH83-00020A	CKD-RESONATOR-CERAMIC;VR9038,3.64MH	1	SNA		DAR12	2007-000082	R-CHIP;3.3Kohm,5%,1/10W,TP,1608	1	SA	
	AK83-01003A	CKD-DOOR-BATTERY;VR9047,ABS(HF-0680	1	SNA		DAR13	2007-000082	R-CHIP;3.3Kohm,5%,1/10W,TP,1608	1	SA	
						DAR14	2007-000123	R-CHIP;1.5Kohm,5%,1/10W,TP,1608	1	SA	
	PCB-MPEG AH92-03015A	ASSY PCB DECK;MPEG,MAX-G25,DVD,-	1	SA		DAR15	2007-000123	R-CHIP;1.5Kohm,5%,1/10W,TP,1608	1	SA	
	BIC1	0801-002683 IC-CMOS LOGIC;74HCT245,TRANSCEIVER,	1	SA		DAR16	2007-000090	R-CHIP;10Kohm,5%,1/10W,TP,1608	1	SA	
	C1	2401-003010 C-AL;1000uF,20%,6.3V,GP,TP,8x11.5mm	1	SA		DAR17	2007-000090	R-CHIP;10Kohm,5%,1/10W,TP,1608	1	SA	
	C10	2203-005148 C-CER,CHIP;100nF,10%,16V,X7R,TP,160	1	SA		DAR18	2007-000074	R-CHIP;100ohm,5%,1/10W,TP,1608	1	SA	
	C11	2203-005148 C-CER,CHIP;100nF,10%,16V,X7R,TP,160	1	SA		DAR19	2007-000074	R-CHIP;100ohm,5%,1/10W,TP,1608	1	SA	
	C12	2203-005148 C-CER,CHIP;100nF,10%,16V,X7R,TP,160	1	SA		DAR2	2007-000113	R-CHIP;33ohm,5%,1/10W,TP,1608	1	SA	
	C13	2203-005148 C-CER,CHIP;100nF,10%,16V,X7R,TP,160	1	SA		DAR20	2007-000309	R-CHIP;10ohm,5%,1/10W,TP,1608	1	SA	
	C14	2203-005148 C-CER,CHIP;100nF,10%,16V,X7R,TP,160	1	SA		DAR21	2007-000309	R-CHIP;10ohm,5%,1/10W,TP,1608	1	SA	
	C15	2203-000626 C-CER,CHIP;0.022nF,5%,50V,C0G,1608	1	SA		DAR22	2007-000097	R-CHIP;47Kohm,5%,1/10W,TP,1608	1	SA	
	C16	2203-005148 C-CER,CHIP;100nF,10%,16V,X7R,TP,160	1	SA		DAR23	2007-000097	R-CHIP;47Kohm,5%,1/10W,TP,1608	1	SA	
	C17	2203-005148 C-CER,CHIP;100nF,10%,16V,X7R,TP,160	1	SA		DAR3	2007-000113	R-CHIP;33ohm,5%,1/10W,TP,1608	1	SA	
	C18	2203-005148 C-CER,CHIP;100nF,10%,16V,X7R,TP,160	1	SA		DAR4	2007-000113	R-CHIP;33ohm,5%,1/10W,TP,1608	1	SA	
	C19	2203-005148 C-CER,CHIP;100nF,10%,16V,X7R,TP,160	1	SA		DAR5	2007-000113	R-CHIP;33ohm,5%,1/10W,TP,1608	1	SA	
	C2	2203-005148 C-CER,CHIP;100nF,10%,16V,X7R,TP,160	1	SA		DAR6	2007-000113	R-CHIP;33ohm,5%,1/10W,TP,1608	1	SA	
	C20	2203-000440 C-CER,CHIP;1nF,10%,50V,X7R,1608	1	SA		DAR7	2007-000113	R-CHIP;33ohm,5%,1/10W,TP,1608	1	SA	
	C21	2203-000669 C-CER,CHIP;27nF,10%,25V,X7R,1608	1	SA		DAR8	2007-000070	R-CHIP;0ohm,5%,1/10W,TP,1608	1	SA	
	C22	2203-000669 C-CER,CHIP;27nF,10%,25V,X7R,1608	1	SA		DAR9	2007-000070	R-CHIP;0ohm,5%,1/10W,TP,1608	1	SA	
	C23	2203-000440 C-CER,CHIP;1nF,10%,50V,X7R,1608	1	SA		DC10	2203-006361	C-CER,CHIP;10000nF,10%,10V,X5R,TP,2	1	SA	
	C24	2203-005148 C-CER,CHIP;100nF,10%,16V,X7R,TP,160	1	SA		DC3	2203-005148	C-CER,CHIP;100nF,10%,16V,X7R,TP,160	1	SA	
	C25	2203-005148 C-CER,CHIP;100nF,10%,16V,X7R,TP,160	1	SA		DC4	2401-002042	C-AL;220uF,20%,10V,GP,TP,6.3x11,5	1	SA	
	C26	2203-005148 C-CER,CHIP;100nF,10%,16V,X7R,TP,160	1	SA		DC5	2203-005148	C-CER,CHIP;100nF,10%,16V,X7R,TP,160	1	SA	
	C27	2203-000332 C-CER,CHIP;0.012nF,5%,50V,C0G,1608	1	SA		DC5A	2203-005148	C-CER,CHIP;100nF,10%,16V,X7R,TP,160	1	SA	
	C28	2203-005148 C-CER,CHIP;100nF,10%,16V,X7R,TP,160	1	SA		DC6	2401-002042	C-AL;220uF,20%,10V,GP,TP,6.3x11,5	1	SA	
	C3	2203-005148 C-CER,CHIP;100nF,10%,16V,X7R,TP,160	1	SA		DC7	2203-005148	C-CER,CHIP;100nF,10%,16V,X7R,TP,160	1	SA	
	C4	2203-005148 C-CER,CHIP;100nF,10%,16V,X7R,TP,160	1	SA		DD2	0407-000123	DIODE-ARRAY;DAN202K,80V,100mA,CA2-3	1	SA	
	C5	2203-005148 C-CER,CHIP;100nF,10%,16V,X7R,TP,160	1	SA		DIC1	1003-001978	IC-MOTOR DRIVER;AM5766,HSOP28H,28P,	1	SA	
	C6	2203-005148 C-CER,CHIP;100nF,10%,16V,X7R,TP,160	1	SA		DR1	2007-000029	R-CHIP;0ohm,5%,1/8W,TP,2012	1	SA	
	C7	2401-002042 C-AL;220uF,20%,10V,GP,TP,6.3x11,5	1	SA		DR15	2007-000070	R-CHIP;0ohm,5%,1/10W,TP,1608	1	SA	

Exploded View & Part List

Loc. No.	Part No.	Description;Specification	Q'ty	SNA	Remark	Loc. No.	Part No.	Description;Specification	Q'ty	SNA	Remark
DR16	2007-000805	R-CHIP;36Kohm,5%,1/10W,TP,1608	1	SA		KC16	2203-000189	C-CER,CHIP;100nF,+80-20%,25V,Y5V,16	1	SA	
DR17	2007-000080	R-CHIP;2Kohm,5%,1/10W,TP,1608	1	SA		KC17	2203-000189	C-CER,CHIP;100nF,+80-20%,25V,Y5V,16	1	SA	
DR18	2007-000080	R-CHIP;2Kohm,5%,1/10W,TP,1608	1	SA		KC18	2203-005065	C-CER,CHIP;1000nF,+80-20%,10V,Y5V,1	1	SA	
DR19	2007-000084	R-CHIP;4.7Kohm,5%,1/10W,TP,1608	1	SA		KC19	2203-000189	C-CER,CHIP;100nF,+80-20%,25V,Y5V,16	1	SA	
DR19A	2007-000078	R-CHIP;1Kohm,5%,1/10W,TP,1608	1	SA		KC2	2203-000257	C-CER,CHIP;10nF,10%,50V,X7R,TP,1608	1	SA	
DR19B	2007-000078	R-CHIP;1Kohm,5%,1/10W,TP,1608	1	SA		KC20	2203-000715	C-CER,CHIP;3.3nF,10%,50V,X7R,1608	1	SA	
DR2	2007-000504	R-CHIP;2.2ohm,5%,1/4W,TP,3216	1	SA		KC21	2401-001975	C-AL;47uF,20%,16V,GP,TP,5x11mm,5mm	1	SA	
DR20	2007-000130	R-CHIP;39Kohm,5%,1/10W,TP,1608	1	SA		KC3	2203-000715	C-CER,CHIP;3.3nF,10%,50V,X7R,1608	1	SA	
DR21	2007-000805	R-CHIP;36Kohm,5%,1/10W,TP,1608	1	SA		KC4	2203-001596	C-CER,CHIP;2200nF,+80-20%,50V,Y5V,2	1	SA	
EL5	2007-000070	R-CHIP;0ohm,5%,1/10W,TP,1608	1	SA		KC5	2203-005015	C-CER,CHIP;150nF,+80-20%,16V,Y5V,16	1	SA	
EL7	2007-000070	R-CHIP;0ohm,5%,1/10W,TP,1608	1	SA		KC6	2203-005065	C-CER,CHIP;1000nF,+80-20%,10V,Y5V,1	1	SA	
EL8	2007-000070	R-CHIP;0ohm,5%,1/10W,TP,1608	1	SA		KC7	2203-000236	C-CER,CHIP;0.1nF,5%,50V,COG,1608	1	SA	
EMS1	0406-001128	DIODE-TVS;MLVS-0603-E08,50V	1	SA		KC8	2203-005065	C-CER,CHIP;1000nF,+80-20%,10V,Y5V,1	1	SA	
EMS2	0406-001128	DIODE-TVS;MLVS-0603-E08,50V	1	SA		KC9	2203-001126	C-CER,CHIP;0.68nF,10%,50V,X7R,1608	1	SA	
FC22	2203-001596	C-CER,CHIP;2200nF,+80-20%,50V,Y5V,2	1	SA		KIC1	1204-002731	IC-AUDIO PROCESSOR;R2A15906SP,SOP,2	1	SA	
FC23	2203-001596	C-CER,CHIP;2200nF,+80-20%,50V,Y5V,2	1	SA		KR1	2007-000124	R-CHIP;2.2Kohm,5%,1/10W,TP,1608	1	SA	
FC35	2203-001607	C-CER,CHIP;0.22nF,5%,50V,NP0,1608	1	SA		KR10	2007-000134	R-CHIP;33Kohm,5%,1/10W,TP,1608	1	SA	
FC36	2203-001607	C-CER,CHIP;0.22nF,5%,50V,NP0,1608	1	SA		KR11	2007-000134	R-CHIP;33Kohm,5%,1/10W,TP,1608	1	SA	
FR1	2007-000070	R-CHIP;0ohm,5%,1/10W,TP,1608	1	SA		KR2	2007-000129	R-CHIP;27Kohm,5%,1/10W,TP,1608	1	SA	
FR23	2007-000097	R-CHIP;47Kohm,5%,1/10W,TP,1608	1	SA		KR22	2007-000092	R-CHIP;15Kohm,5%,1/10W,TP,1608	1	SA	
FR24	2007-000097	R-CHIP;47Kohm,5%,1/10W,TP,1608	1	SA		KR23	2007-000092	R-CHIP;15Kohm,5%,1/10W,TP,1608	1	SA	
FR25	2007-001179	R-CHIP;8.2Kohm,5%,1/10W,TP,1608	1	SA		KR24	2007-000092	R-CHIP;15Kohm,5%,1/10W,TP,1608	1	SA	
FR26	2007-001179	R-CHIP;8.2Kohm,5%,1/10W,TP,1608	1	SA		KR3	2007-001010	R-CHIP;51Kohm,5%,1/10W,TP,1608	1	SA	
FR3	2007-000070	R-CHIP;0ohm,5%,1/10W,TP,1608	1	SA		KR4	2007-000092	R-CHIP;15Kohm,5%,1/10W,TP,1608	1	SA	
HEATSINK	AH62-00062J	HEAT SINK-MPEG;AL,T2,0	1	SA		KR5	2007-000092	R-CHIP;15Kohm,5%,1/10W,TP,1608	1	SA	
HP-JACK	3722-000143	JACK-PHONE;1P(VER),AG,BLK,ANGLE	1	SA		KR6	2007-000092	R-CHIP;15Kohm,5%,1/10W,TP,1608	1	SA	
JB1	3301-001495	BEAD-SMD;120ohm,2012,2500mA,TP,115o	1	SA		KR7	2007-000074	R-CHIP;100ohm,5%,1/10W,TP,1608	1	SA	
JB12	3301-001495	BEAD-SMD;120ohm,2012,2500mA,TP,115o	1	SA		KR8	2007-000091	R-CHIP;12Kohm,5%,1/10W,TP,1608	1	SA	
JB13	3301-001495	BEAD-SMD;120ohm,2012,2500mA,TP,115o	1	SA		KR9	2007-000084	R-CHIP;4.7Kohm,5%,1/10W,TP,1608	1	SA	
JB2	3301-001495	BEAD-SMD;120ohm,2012,2500mA,TP,115o	1	SA		MC15A	2203-000236	C-CER,CHIP;0.1nF,5%,50V,COG,1608	1	SA	
JB3	3301-001495	BEAD-SMD;120ohm,2012,2500mA,TP,115o	1	SA		MC22	2203-005148	C-CER,CHIP;100nF,10%,16V,X7R,TP,160	1	SA	
JB4	3301-001495	BEAD-SMD;120ohm,2012,2500mA,TP,115o	1	SA		MC23	2203-006361	C-CER,CHIP;1000nF,10%,10V,X5R,TP,2	1	SA	
JB5	3301-001495	BEAD-SMD;120ohm,2012,2500mA,TP,115o	1	SA		MC30	2203-005148	C-CER,CHIP;100nF,10%,16V,X7R,TP,160	1	SA	
JB6	3301-001495	BEAD-SMD;120ohm,2012,2500mA,TP,115o	1	SA		MC31	2203-005148	C-CER,CHIP;100nF,10%,16V,X7R,TP,160	1	SA	
JB7	2007-000033	R-CHIP;0ohm,5%,1/4W,TP,3216	1	SA		MC32	2203-005148	C-CER,CHIP;100nF,10%,16V,X7R,TP,160	1	SA	
JC1	2203-005148	C-CER,CHIP;100nF,10%,16V,X7R,TP,160	1	SA		MC33	2203-005148	C-CER,CHIP;100nF,10%,16V,X7R,TP,160	1	SA	
JC12	2401-001092	C-AL;330uF,20%,10V,GP,-,8x11.5,2.5m	1	SA		MC34	2203-005148	C-CER,CHIP;100nF,10%,16V,X7R,TP,160	1	SA	
JC3	2203-005148	C-CER,CHIP;100nF,10%,16V,X7R,TP,160	1	SA		MC35	2203-005148	C-CER,CHIP;100nF,10%,16V,X7R,TP,160	1	SA	
JC4	2203-005221	C-CER,CHIP;15nF,10%,50V,X7R,1608	1	SA		MC36	2203-005148	C-CER,CHIP;100nF,10%,16V,X7R,TP,160	1	SA	
JC5	2203-005221	C-CER,CHIP;15nF,10%,50V,X7R,1608	1	SA		MC37	2203-005148	C-CER,CHIP;100nF,10%,16V,X7R,TP,160	1	SA	
JC6	2203-005148	C-CER,CHIP;100nF,10%,16V,X7R,TP,160	1	SA		MC38	2203-005148	C-CER,CHIP;100nF,10%,16V,X7R,TP,160	1	SA	
JC7	2401-001092	C-AL;330uF,20%,10V,GP,-,8x11.5,2.5m	1	SA		MC39	2203-000815	C-CER,CHIP;0.033nF,5%,50V,COG,1608	1	SA	
JC8	2203-005221	C-CER,CHIP;15nF,10%,50V,X7R,1608	1	SA		MC40	2203-000440	C-CER,CHIP;1nF,10%,50V,X7R,1608	1	SA	
JC9	2203-005221	C-CER,CHIP;15nF,10%,50V,X7R,1608	1	SA		MC41	2203-000440	C-CER,CHIP;1nF,10%,50V,X7R,1608	1	SA	
JCW1	3708-000249	CONNECTOR-FPC/FFC/PIC;27P,1.25mm,ST	1	SA		MC42	2203-005148	C-CER,CHIP;100nF,10%,16V,X7R,TP,160	1	SA	
JCW2	AH39-00291A	LEAD CONNECTOR ASSY;RCA300,1007#26,	1	SA		MC43	2203-006361	C-CER,CHIP;1000nF,10%,10V,X5R,TP,2	1	SA	
JL1	2703-000275	INDUCTOR-SMD;33UH,10%,2012	1	SA		MC44	2203-005148	C-CER,CHIP;100nF,10%,16V,X7R,TP,160	1	SA	
JL2	2703-000275	INDUCTOR-SMD;33UH,10%,2012	1	SA		MC45	2203-006361	C-CER,CHIP;1000nF,10%,10V,X5R,TP,2	1	SA	
JR1	2007-000070	R-CHIP;0ohm,5%,1/10W,TP,1608	1	SA		MC46	2203-006361	C-CER,CHIP;1000nF,10%,10V,X5R,TP,2	1	SA	
JR3	2007-000090	R-CHIP;10Kohm,5%,1/10W,TP,1608	1	SA		MC47	2203-005148	C-CER,CHIP;100nF,10%,16V,X7R,TP,160	1	SA	
KB1	3301-001495	BEAD-SMD;120ohm,2012,2500mA,TP,115o	1	SA		MC48	2203-005148	C-CER,CHIP;100nF,10%,16V,X7R,TP,160	1	SA	
KC1	2203-001596	C-CER,CHIP;2200nF,+80-20%,50V,Y5V,2	1	SA		MC49	2203-005148	C-CER,CHIP;100nF,10%,16V,X7R,TP,160	1	SA	
KC10	2401-000414	C-AL;10uF,20%,16V,GP,TP,4x7,5	1	SA		MC50	2203-005148	C-CER,CHIP;100nF,10%,16V,X7R,TP,160	1	SA	
KC11	2401-001952	C-AL;4.7uF,20%,50V,GP,TP,5x7mm,5mm	1	SA		MC51	2203-006361	C-CER,CHIP;1000nF,10%,10V,X5R,TP,2	1	SA	
KC12	2203-000189	C-CER,CHIP;100nF,+80-20%,25V,Y5V,16	1	SA		MC52	2203-005148	C-CER,CHIP;100nF,10%,16V,X7R,TP,160	1	SA	
KC13	2203-005065	C-CER,CHIP;1000nF,+80-20%,10V,Y5V,1	1	SA		MC53	2203-000681	C-CER,CHIP;0.027nF,5%,50V,COG,1608	1	SA	
KC14	2203-000189	C-CER,CHIP;100nF,+80-20%,25V,Y5V,16	1	SA		MC54	2203-000681	C-CER,CHIP;0.027nF,5%,50V,COG,1608	1	SA	
KC15	2203-001126	C-CER,CHIP;0.68nF,10%,50V,X7R,1608	1	SA		MC55	2203-005148	C-CER,CHIP;100nF,10%,16V,X7R,TP,160	1	SA	

Loc. No.	Part No.	Description;Specification	Q'ty	SNA	Remark	Loc. No.	Part No.	Description;Specification	Q'ty	SNA	Remark
MC56	2203-005148	C-CER,CHIP;100nF,10%,16V,X7R,TP,160	1	SA		R4	2007-000078	R-CHIP;1Kohm,5%,1/10W,TP,1608	1	SA	
MC57	2203-006361	C-CER,CHIP;10000nF,10%,10V,X5R,TP,2	1	SA							
MC58	2203-005148	C-CER,CHIP;100nF,10%,16V,X7R,TP,160	1	SA		R5	2007-000078	R-CHIP;1Kohm,5%,1/10W,TP,1608	1	SA	
MC60	2203-006361	C-CER,CHIP;10000nF,10%,10V,X5R,TP,2	1	SA		R6	2007-000113	R-CHIP;33ohm,5%,1/10W,TP,1608	1	SA	
MC61	2203-005148	C-CER,CHIP;100nF,10%,16V,X7R,TP,160	1	SA		R7	2007-000084	R-CHIP;4.7Kohm,5%,1/10W,TP,1608	1	SA	
						R8	2007-000084	R-CHIP;4.7Kohm,5%,1/10W,TP,1608	1	SA	
						R9	2007-000084	R-CHIP;4.7Kohm,5%,1/10W,TP,1608	1	SA	
MIC1	1204-002955	IC-DECODER,ZR36966PQCG-XE2,TR,128P,	1	SA							
MIC2	1107-001600	IC-NOR FLASH;MX25L1605A,16Mbit,2Mx8	1	SA							
MIC3C	1105-001261	IC-DRAM;12L1616A,16,TSOP,50P,400MIL	1	SA		RFC1	2203-005148	C-CER,CHIP;100nF,10%,16V,X7R,TP,160	1	SA	
MIC4	1103-001398	IC-EEPROM;24C02,2Kbit,256Kx8,SOIC,8	1	SA		RFC10	2203-005148	C-CER,CHIP;100nF,10%,16V,X7R,TP,160	1	SA	
MIC-JACK	3722-000143	JACK-PHONE;1P(VER),AG,BLK,ANGLE	1	SA		RFC10A	2203-005148	C-CER,CHIP;100nF,10%,16V,X7R,TP,160	1	SA	
						RFC2	2401-001092	C-AL;330uF,20%,10V,GP,-,8x11.5,2.5m	1	SA	
						RFC3	2203-005148	C-CER,CHIP;100nF,10%,16V,X7R,TP,160	1	SA	
ML1	3301-001495	BEAD-SMD;120ohm,2012,2500mA,TP,115o	1	SA							
ML2	3301-001495	BEAD-SMD;120ohm,2012,2500mA,TP,115o	1	SA							
ML3	3301-001495	BEAD-SMD;120ohm,2012,2500mA,TP,115o	1	SA		RFC4	2203-006361	C-CER,CHIP;10000nF,10%,10V,X5R,TP,2	1	SA	
ML4	3301-001495	BEAD-SMD;120ohm,2012,2500mA,TP,115o	1	SA		RFC5	2203-005148	C-CER,CHIP;100nF,10%,16V,X7R,TP,160	1	SA	
MR1	2007-000084	R-CHIP;4.7Kohm,5%,1/10W,TP,1608	1	SA		RFC6	2203-005148	C-CER,CHIP;100nF,10%,16V,X7R,TP,160	1	SA	
						RFC7	2401-000042	C-AL;100uF,20%,16V,GP,TP,6.3x7.5	1	SA	
						RFC8	2401-000042	C-AL;100uF,20%,16V,GP,TP,6.3x7.5	1	SA	
MR10	2007-000113	R-CHIP;33ohm,5%,1/10W,TP,1608	1	SA		RFC9	2203-005148	C-CER,CHIP;100nF,10%,16V,X7R,TP,160	1	SA	
MR12	2007-000074	R-CHIP;100ohm,5%,1/10W,TP,1608	1	SA		RFCON1	3708-000491	CONNECTOR-FPC/FFC/PIC;23P,1mm,STRAI	1	SA	
MR17	2007-000329	R-CHIP;1Kohm,5%,1/10W,TP,1608	1	SA		RFD1	0407-000116	DIODE-ARRAY;KDS181, DAP202K,80V,100	1	SA	
MR18	2007-000086	R-CHIP;5.6Kohm,5%,1/10W,TP,1608	1	SA		RFL1	3301-001495	BEAD-SMD;120ohm,2012,2500mA,TP,115o	1	SA	
MR19	2007-000086	R-CHIP;5.6Kohm,5%,1/10W,TP,1608	1	SA		RFL2	3301-001495	BEAD-SMD;120ohm,2012,2500mA,TP,115o	1	SA	
MR2	2007-000084	R-CHIP;4.7Kohm,5%,1/10W,TP,1608	1	SA		RFR1	2007-000134	R-CHIP;33Kohm,5%,1/10W,TP,1608	1	SA	
MR20	2007-008567	R-CHIP;15.4Kohm,1%,1/10W,TP,1608	1	SA		RFR2	2007-000134	R-CHIP;33Kohm,5%,1/10W,TP,1608	1	SA	
MR21	2007-000074	R-CHIP;100ohm,5%,1/10W,TP,1608	1	SA		RFR3	2007-001010	R-CHIP;51Kohm,5%,1/10W,TP,1608	1	SA	
MR22	2007-007277	R-CHIP;392ohm,1%,1/10W,TP,1608	1	SA							
MR23	2007-001167	R-CHIP;75ohm,5%,1/10W,TP,1608	1	SA		RFR4	2007-001146	R-CHIP;7.5ohm,5%,1/8W,TP,2012	1	SA	
						RFR5	2007-000075	R-CHIP;220ohm,5%,1/10W,TP,1608	1	SA	
MR24	2007-000109	R-CHIP;1Mohm,5%,1/10W,TP,1608	1	SA		RFR6	2007-001146	R-CHIP;7.5ohm,5%,1/8W,TP,2012	1	SA	
MR25	2007-000081	R-CHIP;2.7Kohm,5%,1/10W,TP,1608	1	SA		RFR7	2007-000075	R-CHIP;220ohm,5%,1/10W,TP,1608	1	SA	
MR26	2007-000078	R-CHIP;1Kohm,5%,1/10W,TP,1608	1	SA		RFR8	2007-000102	R-CHIP;100Kohm,5%,1/10W,TP,1608	1	SA	
MR27	2007-000074	R-CHIP;100ohm,5%,1/10W,TP,1608	1	SA							
MR28	2007-000074	R-CHIP;100ohm,5%,1/10W,TP,1608	1	SA		SHEET COPPER	AH61-10513A	BRACKET-PCB;DAT7000,SUN,T2.0,W85,L1	1	SA	
						USB1	3722-001051	JACK-USB;4P1C,AU,BLK,ANGLE,A TYPE	1	SA	
MR29	2007-000078	R-CHIP;1Kohm,5%,1/10W,TP,1608	1	SA		USC1	2203-000280	C-CER,CHIP;0.01nF,0.5pF,50V,C0G,160	1	SA	
MR30	2007-000078	R-CHIP;1Kohm,5%,1/10W,TP,1608	1	SA		USC2	2203-000280	C-CER,CHIP;0.01nF,0.5pF,50V,C0G,160	1	SA	
MR31	2007-000081	R-CHIP;2.7Kohm,5%,1/10W,TP,1608	1	SA		USL2	3301-001495	BEAD-SMD;120ohm,2012,2500mA,TP,115o	1	SA	
MR32	2007-000081	R-CHIP;2.7Kohm,5%,1/10W,TP,1608	1	SA							
MR33	2007-000084	R-CHIP;4.7Kohm,5%,1/10W,TP,1608	1	SA		USR1	2007-000092	R-CHIP;15Kohm,5%,1/10W,TP,1608	1	SA	
						USR2	2007-000092	R-CHIP;15Kohm,5%,1/10W,TP,1608	1	SA	
MR34	2007-000084	R-CHIP;4.7Kohm,5%,1/10W,TP,1608	1	SA		USR3	2007-000552	R-CHIP;20ohm,5%,1/10W,TP,1608	1	SA	
MR35	2007-000113	R-CHIP;33ohm,5%,1/10W,TP,1608	1	SA		USR4	2007-000552	R-CHIP;20ohm,5%,1/10W,TP,1608	1	SA	
MR36	2007-000070	R-CHIP;0ohm,5%,1/10W,TP,1608	1	SA		VC1	2203-000357	C-CER,CHIP;0.15nF,5%,50V,C0G,1608	1	SA	
MR4	2007-000121	R-CHIP;820ohm,5%,1/10W,TP,1608	1	SA							
MR8	2007-000113	R-CHIP;33ohm,5%,1/10W,TP,1608	1	SA		VC11	2203-000280	C-CER,CHIP;0.01nF,0.5pF,50V,C0G,160	1	SA	
						VC12	2203-000357	C-CER,CHIP;0.15nF,5%,50V,C0G,1608	1	SA	
MR9	2007-000113	R-CHIP;33ohm,5%,1/10W,TP,1608	1	SA		VC13	2203-000357	C-CER,CHIP;0.15nF,5%,50V,C0G,1608	1	SA	
MX1	2801-004284	CRYSTAL-SMD;27MHZ,10PPM,28-AA,20PF	1	SA		VC14	2203-000357	C-CER,CHIP;0.15nF,5%,50V,C0G,1608	1	SA	
PB9	3301-001495	BEAD-SMD;120ohm,2012,2500mA,TP,115o	1	SA		VC15	2203-000357	C-CER,CHIP;0.15nF,5%,50V,C0G,1608	1	SA	
PC1	2203-005148	C-CER,CHIP;100nF,10%,16V,X7R,TP,160	1	SA		VC2	2203-000357	C-CER,CHIP;0.15nF,5%,50V,C0G,1608	1	SA	
PC2	2203-005148	C-CER,CHIP;100nF,10%,16V,X7R,TP,160	1	SA		VC3	2203-000357	C-CER,CHIP;0.15nF,5%,50V,C0G,1608	1	SA	
						VC4	2203-000357	C-CER,CHIP;0.15nF,5%,50V,C0G,1608	1	SA	
PC3	2203-005148	C-CER,CHIP;100nF,10%,16V,X7R,TP,160	1	SA		VC5	2203-000280	C-CER,CHIP;0.01nF,0.5pF,50V,C0G,160	1	SA	
PCB	AH41-01208A	PCB-MPEG;MM-DG25,CEM-3,2,0,T1.6,245	0.5	SNA		VC5A	2401-002042	C-AL;220uF,20%,10V,GP,TP,6.3x11.5	1	SA	
PIC1	1203-002779	IC-POSIX.FIXED REG.;G952T63U,SOT-223	1	SA							
PL1	3301-001495	BEAD-SMD;120ohm,2012,2500mA,TP,115o	1	SA		VC5B	2401-002042	C-AL;220uF,20%,10V,GP,TP,6.3x11.5	1	SA	
PL3	3301-001495	BEAD-SMD;120ohm,2012,2500mA,TP,115o	1	SA		VC7	2203-000280	C-CER,CHIP;0.01nF,0.5pF,50V,C0G,160	1	SA	
						VC9	2203-000280	C-CER,CHIP;0.01nF,0.5pF,50V,C0G,160	1	SA	
R1	2007-000504	R-CHIP;2.2ohm,5%,1/4W,TP,3216	1	SA		VD1	0403-000314	DIODE-ZENER;RLZJ9.1B,8.8-9.3V,500MW	1	SA	
R10	2007-000074	R-CHIP;100ohm,5%,1/10W,TP,1608	1	SA		VD2	0403-000314	DIODE-ZENER;RLZJ9.1B,8.8-9.3V,500MW	1	SA	
R11	2007-000329	R-CHIP;1Kohm,5%,1/10W,TP,1608	1	SA							
R12	2007-000074	R-CHIP;100ohm,5%,1/10W,TP,1608	1	SA		VD3	0403-000314	DIODE-ZENER;RLZJ9.1B,8.8-9.3V,500MW	1	SA	
R13	2007-000074	R-CHIP;100ohm,5%,1/10W,TP,1608	1	SA		VD4	0403-000314	DIODE-ZENER;RLZJ9.1B,8.8-9.3V,500MW	1	SA	
R14	2007-000074	R-CHIP;100ohm,5%,1/10W,TP,1608	1	SA							
R15	2007-000074	R-CHIP;100ohm,5%,1/10W,TP,1608	1	SA							
R2	2007-000084	R-CHIP;4.7Kohm,5%,1/10W,TP,1608	1	SA							
R3	2007-000084	R-CHIP;4.7Kohm,5%,1/10W,TP,1608	1	SA							

Exploded View & Part List

Loc. No.	Part No.	Description;Specification	Q'ty	SNA	Remark	Loc. No.	Part No.	Description;Specification	Q'ty	SNA	Remark
VD5	0403-000314	DIODE-ZENER;RLZJ9.1B,8.8-9.3V,500MW	1	SA							
VD6	0403-000314	DIODE-ZENER;RLZJ9.1B,8.8-9.3V,500MW	1	SA		1SR06	2001-001088	R-CARBON(S);1Kohm,5%,1/2W,AA,TP,2.4	1	SA	
VD7	0403-000314	DIODE-ZENER;RLZJ9.1B,8.8-9.3V,500MW	1	SA		1SR07	2001-001088	R-CARBON(S);1Kohm,5%,1/2W,AA,TP,2.4	1	SA	
						1SR08	2007-000076	R-CHIP;330ohm,5%,1/10W,TP,1608	1	SA	
VD8	0403-000314	DIODE-ZENER;RLZJ9.1B,8.8-9.3V,500MW	1	SA		1SR09	2007-000309	R-CHIP;10ohm,5%,1/10W,TP,1608	1	SA	
VJ3	3722-002042	JACK-PIN;2P/2C,NI,WHT/RED,ANGLE	1	SA		1SR10	2007-000084	R-CHIP;4.7Kohm,5%,1/10W,TP,1608	1	SA	
VL2	2703-001254	INDUCTOR-SMD;1.8uH,10%,2012	1	SA							
VL3	2703-001254	INDUCTOR-SMD;1.8uH,10%,2012	1	SA		1SR12	2001-000502	R-CARBON;20ohm,5%,1/4W,AA,TP,2.4x6.	1	SA	
VL4	2703-001254	INDUCTOR-SMD;1.8uH,10%,2012	1	SA		1SR13	2007-000097	R-CHIP;47Kohm,5%,1/10W,TP,1608	1	SA	
						1SR14	2007-000092	R-CHIP;15Kohm,5%,1/10W,TP,1608	1	SA	
VL5	2703-001254	INDUCTOR-SMD;1.8uH,10%,2012	1	SA		1SR15	2001-000734	R-CARBON;4.7Kohm,5%,1/8W,AA,TP,1.8x	1	SA	
VL6	3301-001069	BEAD-SMD;120ohm,1.6x0.8x0.8mm,200mA	1	SA		1SR16	2007-000074	R-CHIP;100ohm,5%,1/10W,TP,1608	1	SA	
VL7	3301-001069	BEAD-SMD;120ohm,1.6x0.8x0.8mm,200mA	1	SA							
VL8	3301-001069	BEAD-SMD;120ohm,1.6x0.8x0.8mm,200mA	1	SA		1SR18	2003-002440	R-METAL OXIDE(S);0.15ohm,5%,2W,AF,T	1	SA	
VL9	3301-001069	BEAD-SMD;120ohm,1.6x0.8x0.8mm,200mA	1	SA		1SR19	2007-000084	R-CHIP;4.7Kohm,5%,1/10W,TP,1608	1	SA	
						1SR20	2001-000502	R-CARBON;20ohm,5%,1/4W,AA,TP,2.4x6.	1	SA	
VQ8	0501-000002	TR-SMALL SIGNAL;KSA812,PNP,150MW,SO	1	SA		1SR90	2007-000109	R-CHIP;1Mohm,5%,1/10W,TP,1608	1	SA	
VQ8A	0501-000002	TR-SMALL SIGNAL;KSA812,PNP,150MW,SO	1	SA		1SR91	2001-000734	R-CARBON;4.7Kohm,5%,1/8W,AA,TP,1.8x	1	SA	
VR27	2007-000116	R-CHIP;120ohm,5%,1/10W,TP,1608	1	SA							
VR27A	2007-001164	R-CHIP;75ohm,1%,1/10W,TP,1608	1	SA		1SR92	2007-000084	R-CHIP;4.7Kohm,5%,1/10W,TP,1608	1	SA	
VR27B	2007-000116	R-CHIP;120ohm,5%,1/10W,TP,1608	1	SA		1SR93	2007-000084	R-CHIP;4.7Kohm,5%,1/10W,TP,1608	1	SA	
						1SZ05	0403-001318	DIODE-ZENER;MTZJ4.3B,4.17-4.43V,500	1	SA	
VR35	2007-001167	R-CHIP;75ohm,5%,1/10W,TP,1608	1	SA		1SZ90	0403-001062	DIODE-ZENER;UDZ4.7B,4.55-4.75V,200M	1	SA	
VR36	2007-001167	R-CHIP;75ohm,5%,1/10W,TP,1608	1	SA		AB1	3301-000297	BEAD-AXIAL;25ohm,3.6x1.2x5.7mm,-,TP	1	SA	
VR37	2007-001167	R-CHIP;75ohm,5%,1/10W,TP,1608	1	SA							
VR38	2007-001167	R-CHIP;75ohm,5%,1/10W,TP,1608	1	SA		AB2	3301-000297	BEAD-AXIAL;25ohm,3.6x1.2x5.7mm,-,TP	1	SA	
	AH99-00268A	ASSY AUTO INSERT;MAX-G25,MAX-G25,MP	1	SNA		AC1	2203-005249	C-CER,CHIP;100nF,10%,50V,X7R,TP,160	1	SA	
						AC10	2203-005249	C-CER,CHIP;100nF,10%,50V,X7R,TP,160	1	SA	
						AC11	2401-000325	C-AL;100uF,20%,35V,GP,8x11.5mm,3.5m	1	SA	
						AC12	2401-000325	C-AL;100uF,20%,35V,GP,8x11.5mm,3.5m	1	SA	
						AC13	2203-001607	C-CER,CHIP;0.22nF,5%,50V,NP0,1608	1	SA	
						AC14	2203-001607	C-CER,CHIP;0.22nF,5%,50V,NP0,1608	1	SA	
						AC15	2401-000230	C-AL;100uF,20%,100V,GP,TP,12.5x20mm	1	SA	
						AC16	2203-005249	C-CER,CHIP;100nF,10%,50V,X7R,TP,160	1	SA	
						AC17	2203-005221	C-CER,CHIP;15nF,10%,50V,X7R,1608	1	SA	
						AC18	2203-001607	C-CER,CHIP;0.22nF,5%,50V,NP0,1608	1	SA	
						AC19	2203-005249	C-CER,CHIP;100nF,10%,50V,X7R,TP,160	1	SA	
						AC2	2203-000925	C-CER,CHIP;470nF,+80-20%,50V,Y5V,20	1	SA	
						AC20	2203-005218	C-CER,CHIP;470nF,10%,50V,X7R,3216	1	SA	
						AC21	2203-001607	C-CER,CHIP;0.22nF,5%,50V,NP0,1608	1	SA	
						AC22	2203-005249	C-CER,CHIP;100nF,10%,50V,X7R,TP,160	1	SA	
						AC23	2203-005218	C-CER,CHIP;470nF,10%,50V,X7R,3216	1	SA	
						AC24	2203-005221	C-CER,CHIP;15nF,10%,50V,X7R,1608	1	SA	
						AC25	2203-001607	C-CER,CHIP;0.22nF,5%,50V,NP0,1608	1	SA	
						AC26	2203-002392	C-CER,CHIP;220nF,+80-20%,50V,Y5V,20	1	SA	
						AC27	2401-003564	C-AL;1000uF,20%,35V,LZ,TP,12.5X25mm	1	SA	
						AC28	2401-003564	C-AL;1000uF,20%,35V,LZ,TP,12.5X25mm	1	SA	
						AC29	2203-005249	C-CER,CHIP;100nF,10%,50V,X7R,TP,160	1	SA	
						AC3	2203-000440	C-CER,CHIP;1nF,10%,50V,X7R,1608	1	SA	
						AC30	2203-005249	C-CER,CHIP;100nF,10%,50V,X7R,TP,160	1	SA	
						AC31	2203-000925	C-CER,CHIP;470nF,+80-20%,50V,Y5V,20	1	SA	
						AC32	2203-005249	C-CER,CHIP;100nF,10%,50V,X7R,TP,160	1	SA	
						AC33	2203-000236	C-CER,CHIP;0.1nF,5%,50V,COG,1608	1	SA	
						AC34	2203-000925	C-CER,CHIP;470nF,+80-20%,50V,Y5V,20	1	SA	
						AC35	2203-000440	C-CER,CHIP;1nF,10%,50V,X7R,1608	1	SA	
						AC36	2401-001975	C-AL;47uF,20%,16V,GP,TP,5x11mm,5mm	1	SA	
						AC37	2305-000407	C-FILM,LEAD-PEF;470nF,5%,100V,TP,10	1	SA	
						AC38	2305-000407	C-FILM,LEAD-PEF;470nF,5%,100V,TP,10	1	SA	
						AC39	2203-005249	C-CER,CHIP;100nF,10%,50V,X7R,TP,160	1	SA	
						AC4	2203-000236	C-CER,CHIP;0.1nF,5%,50V,COG,1608	1	SA	
						AC40	2203-005249	C-CER,CHIP;100nF,10%,50V,X7R,TP,160	1	SA	
						AC41	2203-005221	C-CER,CHIP;15nF,10%,50V,X7R,1608	1	SA	
						AC42	2203-005249	C-CER,CHIP;100nF,10%,50V,X7R,TP,160	1	SA	
11C01	2401-003030	C-AL;220uF,20%,450V,GP,BK,30x35,10	1	SA							
1SC02	2201-000963	C-CERAMIC,DISC;1NF,20%,400V,Y5U,TP,	1	SA							
1SC03	2201-000963	C-CERAMIC,DISC;1NF,20%,400V,Y5U,TP,	1	SA							
1SC04	2301-001511	C-FILM,LEAD-PEF;330NF,10%,275V,BK,1	1	SA							
1SC05	2301-001220	C-FILM,LEAD-PPF;100nF,10%,275V,BK,1	1	SA							
1SC06	2201-000963	C-CERAMIC,DISC;1NF,20%,400V,Y5U,TP,	1	SA							
1SC07	2201-000128	C-CERAMIC,DISC;0.1NF,10%,1KV,Y5P,BK	1	SA							
1SC08	2305-001016	C-FILM,LEAD-PEF;10nF,10%,630V,TP,12	1	SA							
1SC09	2401-000970	C-AL;22uF,20%,50V,WT,PT,5x11,5	1	SA							
1SC11	2203-000609	C-CER,CHIP;22nF,10%,50V,X7R,TP,2012	1	SA							
1SC16	2203-001128	C-CER,CHIP;0.68nF,10%,50V,X7R,TP,20	1	SA							
1SC17	2203-001128	C-CER,CHIP;0.68nF,10%,50V,X7R,TP,20	1	SA							
1SC18	2201-002065	C-CERAMIC,DISC;47pF,10%,1KV,SL,TP,6	1	SA							
1SC90	2305-000407	C-FILM,LEAD-PEF;470nF,5%,100V,TP,10	1	SA							
1SC91	2305-001016	C-FILM,LEAD-PEF;10nF,10%,630V,TP,12	1	SA							
1SCN1	3711-000203	HEADER-BOARD TO CABLE;1WALL,2P/3P,1	1	SA							
1SD1	0402-001258	DIODE-BRIDGE;GBU606,600V,6A,SIP,4-B	1	SA							
1SD2	0401-000005	DIODE-SWITCHING;1N4148,75V,150mA,DO	1	SA							
1SD5	0402-000012	DIODE-RECTIFIER;UF4007,1000V,1A,DO-	1	SA							
1SD7	0402-000274	DIODE-RECTIFIER;UF4004,400V,1A,DO-4	1	SA							
1SD8	0402-000274	DIODE-RECTIFIER;UF4004,400V,1A,DO-4	1	SA							
1SD9	0402-000274	DIODE-RECTIFIER;UF4004,400V,1A,DO-4	1	SA							
1SD90	0401-000005	DIODE-SWITCHING;1N4148,75V,150mA,DO	1	SA							
1SF01	3601-001127	FUSE-RADIAL LEAD;250V,3.15A,TIME-LA	1	SA							
1SIC01	1203-004788	IC-PWM CONTROLLER;ICE2QS01,DIP,8P,9	1	SA							
1SIC02	0604-000117	PHOTO-COUPLER;TR,130-260%,200mW,DIP	1	SA							
1SIC03	1203-000187	IC-POS.ADJUST REG.;431,TO-92,3P,-,	1	SA							
1SL01	3301-000297	BEAD-AXIAL;25ohm,3.6x1.2x5.7mm,-,TP	1	SA							
1SL02	AH29-00017A	FILTER LINE NOISE;SWA-4100,WXSQ28-4	1	SA							
1SQ02	0501-002409	TR-SMALL SIGNAL;KTC945B,NPN,625mW,T	1	SA							
1SR02	2003-000994	R-METAL OXIDE(S);33Kohm,5%,2W,AF,TP	1	SA							
1SR03	2003-000994	R-METAL OXIDE(S);33Kohm,5%,2W,AF,TP	1	SA							
1SR04	1404-001195	THERMISTOR-NTC;5.1ohm,3.84A,3000K,2	1	SA							
1SR05	2001-001088	R-CARBON(S);1Kohm,5%,1/2W,AA,TP,2.4	1	SA							

Loc. No.	Part No.	Description;Specification	Q'ty	SNA	Remark	Loc. No.	Part No.	Description;Specification	Q'ty	SNA	Remark
AC45	2401-000414	C-AL;10uF,20%,16V,GP,TP,4x7,5	1	SA		C1P95	2203-000206	C-CER,CHIP;100nF,10%,50V,X7R,TP,201	1	SA	
AC47	2203-005249	C-CER,CHIP;100nF,10%,50V,X7R,TP,160	1	SA		C1P96	2203-000206	C-CER,CHIP;100nF,10%,50V,X7R,TP,201	1	SA	
						C1P97	2203-000206	C-CER,CHIP;100nF,10%,50V,X7R,TP,201	1	SA	
AC48	2203-005221	C-CER,CHIP;15nF,10%,50V,X7R,1608	1	SA		C1P98	2203-002793	C-CER,CHIP;1000nF,+80-20%,25V,Y5V,2	1	SA	
AC5	2203-005249	C-CER,CHIP;100nF,10%,50V,X7R,TP,160	1	SA							
AC6	2203-000925	C-CER,CHIP;470nF,+80-20%,50V,Y5V,20	1	SA		C1P99	2203-000206	C-CER,CHIP;100nF,10%,50V,X7R,TP,201	1	SA	
AC7	2203-005249	C-CER,CHIP;100nF,10%,50V,X7R,TP,160	1	SA		C1S30	2401-001928	C-AL;2200uF,20%,35V,GP,BK,16x31mm,7	1	SA	
AC8	2203-005249	C-CER,CHIP;100nF,10%,50V,X7R,TP,160	1	SA		C1S32	2401-001415	C-AL;470uF,20%,35V,GP,TP,10x20,5	1	SA	
						C1S33	2401-001928	C-AL;2200uF,20%,35V,GP,BK,16x31mm,7	1	SA	
						C1S35	2401-001415	C-AL;470uF,20%,35V,GP,TP,10x20,5	1	SA	
AC9	2203-005249	C-CER,CHIP;100nF,10%,50V,X7R,TP,160	1	SA							
AD2	0403-000149	DIODE-ZENER;1N4742A,5%,1000MW,DO-41	1	SA		C1S36	2201-000128	C-CERAMIC,DISC;0.1NF,10%,1KV,Y5P,BK	1	SA	
AIC1	1201-002612	IC-AUDIO AMP;TDA8920BJ,DBS,23P,30.2	1	SA		C1S37	2201-000281	C-CERAMIC,DISC;1NF,+80-20%,50V,Y5V,	1	SA	
AJ1	3716-001242	TERMINAL-BLOCK;WIRE TYPE,4P,4.5mm,0	1	SA		C1S41	2401-000042	C-AL;100uF,20%,16V,GP,TP,6.3x7,5	1	SA	
AL1	AH27-00067A	COIL FILTER;MAX-DA75,22.4uH,50m Ohm	1	SA		C1S42	2203-000260	C-CER,CHIP;10nF,10%,50V,X7R,2012	1	SA	
						C1S43	2401-003069	C-AL;470uF,20%,50V,WT,TP,10x20mm,5	1	SA	
AL2	AH27-00067A	COIL FILTER;MAX-DA75,22.4uH,50m Ohm	1	SA							
AMP HEAT-SINK	AH62-00185A	HEAT SINK-MAIN;MM-DA25,AL SHEET T3,	1	SA		D1P100	0401-000005	DIODE-SWITCHING;1N4148,75V,150mA,DO	1	SA	
AQ1	0501-000341	TR-SMALL SIGNAL;KSC1623-L,NPN,200mW	1	SA		D1P101	0402-000268	DIODE-RECTIFIER;SB360,60V,3A,DO-201	1	SA	
AR1	2007-000129	R-CHIP;27Kohm,5%,1/10W,TP,1608	1	SA		D1P102	0402-000268	DIODE-RECTIFIER;SB360,60V,3A,DO-201	1	SA	
AR10	2001-000019	R-CARBON(S);10ohm,5%,1/2W,AA,TP,2.4	1	SA		D1P103	3811-001868	WIRE-NO SHEATH CU;SnCuFe,52mm,GRY	1	SA	
						D1P104	3811-001868	WIRE-NO SHEATH CU;SnCuFe,52mm,GRY	1	SA	
AR11	2007-000129	R-CHIP;27Kohm,5%,1/10W,TP,1608	1	SA							
AR12	2007-000078	R-CHIP;1Kohm,5%,1/10W,TP,1608	1	SA		D1P105	3811-001868	WIRE-NO SHEATH CU;SnCuFe,52mm,GRY	1	SA	
AR13	2003-000587	R-METAL OXIDE(S);22ohm,5%,1W,AA,TP,	1	SA		D1P106	0401-000005	DIODE-SWITCHING;1N4148,75V,150mA,DO	1	SA	
AR14	2003-000587	R-METAL OXIDE(S);22ohm,5%,1W,AA,TP,	1	SA		D1P107	0401-000005	DIODE-SWITCHING;1N4148,75V,150mA,DO	1	SA	
AR18	2007-000079	R-CHIP;1.8Kohm,5%,1/10W,TP,1608	1	SA		D1P108	0401-000005	DIODE-SWITCHING;1N4148,75V,150mA,DO	1	SA	
						D1P109	0401-000005	DIODE-SWITCHING;1N4148,75V,150mA,DO	1	SA	
AR2	2007-000086	R-CHIP;5.6Kohm,5%,1/10W,TP,1608	1	SA							
AR20	2007-000094	R-CHIP;22Kohm,5%,1/10W,TP,1608	1	SA		D1P110	0403-000355	DIODE-ZENER;UZ5.1BSB,5-5.2V,500MWD	1	SA	
AR21	2007-000094	R-CHIP;22Kohm,5%,1/10W,TP,1608	1	SA		D1P111	0403-001318	DIODE-ZENER;MTZJ4.3B,4.17-4.43V,500	1	SA	
AR22	2007-000094	R-CHIP;22Kohm,5%,1/10W,TP,1608	1	SA		D1P99	0402-000012	DIODE-RECTIFIER;UF4007,1000V,1A,DO-	1	SA	
AR23	2007-000124	R-CHIP;2.2Kohm,5%,1/10W,TP,1608	1	SA		D1S30	0402-000012	DIODE-RECTIFIER;UF4007,1000V,1A,DO-	1	SA	
						D1S31	0402-000012	DIODE-RECTIFIER;UF4007,1000V,1A,DO-	1	SA	
AR3	2007-000086	R-CHIP;5.6Kohm,5%,1/10W,TP,1608	1	SA							
AR4	2001-001178	R-CARBON(S);680ohm,5%,1/2W,AA,TP,2.	1	SA		D1S32	0402-001587	DIODE-RECTIFIER;SFAF504G,200V,5A,IT	1	SA	
AR5	2001-000019	R-CARBON(S);10ohm,5%,1/2W,AA,TP,2.4	1	SA		D1S3236 HS	AK62-00009A	HEAT SINK-MAIN;DVD-CM350,AL1050R,T1	2	SA	
AR6	2007-000312	R-CHIP;10ohm,5%,1/4W,TP,3216	1	SA		D1S35	0402-001587	DIODE-RECTIFIER;SFAF504G,200V,5A,IT	1	SA	
AR7	2007-000312	R-CHIP;10ohm,5%,1/4W,TP,3216	1	SA		FC10	2203-001596	C-CER,CHIP;2200nF,+80-20%,50V,Y5V,2	1	SA	
						FC11	2203-001596	C-CER,CHIP;2200nF,+80-20%,50V,Y5V,2	1	SA	
AR8	2007-000086	R-CHIP;5.6Kohm,5%,1/10W,TP,1608	1	SA							
AR9	2007-000086	R-CHIP;5.6Kohm,5%,1/10W,TP,1608	1	SA							
C1P100	2401-000651	C-AL;2.2uF,20%,50V,GP,TP,4x7,5	1	SA		FC14	2203-005171	C-CER,CHIP;1000nF,10%,16V,X7R,2012	1	SA	
C1P101	2203-000206	C-CER,CHIP;100nF,10%,50V,X7R,TP,201	1	SA		FC15	2203-000236	C-CER,CHIP;0.1nF,5%,50V,COG,1608	1	SA	
C1P102	2203-000206	C-CER,CHIP;100nF,10%,50V,X7R,TP,201	1	SA		FC16	2203-000236	C-CER,CHIP;0.1nF,5%,50V,COG,1608	1	SA	
						FC17	2203-001596	C-CER,CHIP;2200nF,+80-20%,50V,Y5V,2	1	SA	
C1P103	2203-000206	C-CER,CHIP;100nF,10%,50V,X7R,TP,201	1	SA		FC18	2203-001596	C-CER,CHIP;2200nF,+80-20%,50V,Y5V,2	1	SA	
C1P104	2401-000325	C-AL;100uF,20%,35V,GP,8x11.5mm,3.5m	1	SA							
C1P105	2401-000129	C-AL;1000uF,20%,16V,GP,-,10x16mm,5	1	SA		FC19	2203-001222	C-CER,CHIP;0.82nF,10%,50V,X7R,1608	1	SA	
C1P106	2203-000206	C-CER,CHIP;100nF,10%,50V,X7R,TP,201	1	SA		FC20	2203-001596	C-CER,CHIP;2200nF,+80-20%,50V,Y5V,2	1	SA	
C1P107	2203-000206	C-CER,CHIP;100nF,10%,50V,X7R,TP,201	1	SA		FC21	2203-001222	C-CER,CHIP;0.82nF,10%,50V,X7R,1608	1	SA	
						FC24	2203-001596	C-CER,CHIP;2200nF,+80-20%,50V,Y5V,2	1	SA	
C1P108	2401-000325	C-AL;100uF,20%,35V,GP,8x11.5mm,3.5m	1	SA		FC25	2203-001140	C-CER,CHIP;68nF,10%,16V,X7R,1608	1	SA	
C1P109	2401-000118	C-AL;1000uF,20%,10V,GP,TP,10x12.5,5	1	SA		FC26	2203-001140	C-CER,CHIP;68nF,10%,16V,X7R,1608	1	SA	
C1P110	2401-002300	C-AL;47#FF,20%,50V,GP,TP,6.3x11,5mm	1	SA		FC27	2203-001140	C-CER,CHIP;68nF,10%,16V,X7R,1608	1	SA	
C1P111	2401-000804	C-AL;220uF,20%,16V,GP,TP,8x9mm,5	1	SA		FC28	2203-000972	C-CER,CHIP;47nF,10%,16V,X7R,1608	1	SA	
C1P112	2203-002793	C-CER,CHIP;1000nF,+80-20%,25V,Y5V,2	1	SA		FC29	2203-005249	C-CER,CHIP;100nF,10%,50V,X7R,TP,160	1	SA	
						FC30	2203-000998	C-CER,CHIP;0.047nF,5%,50V,COG,1608	1	SA	
C1P113	2203-001537	C-CER,CHIP;1nF,10%,50V,X7R,TP,2012	1	SA							
C1P114	2203-001537	C-CER,CHIP;1nF,10%,50V,X7R,TP,2012	1	SA		FC31	2203-001607	C-CER,CHIP;0.22nF,5%,50V,NP0,1608	1	SA	
C1P115	2203-000206	C-CER,CHIP;100nF,10%,50V,X7R,TP,201	1	SA		FC32	2203-000998	C-CER,CHIP;0.047nF,5%,50V,COG,1608	1	SA	
C1P116	2203-006361	C-CER,CHIP;10000nF,10%,10V,X5R,TP,2	1	SA		FC33	2203-001607	C-CER,CHIP;0.22nF,5%,50V,NP0,1608	1	SA	
C1P117	2401-003010	C-AL;1000uF,20%,6.3V,GP,TP,8x11.5mm	1	SA		FC34	2203-005249	C-CER,CHIP;100nF,10%,50V,X7R,TP,160	1	SA	
						FC8	2401-000042	C-AL;100uF,20%,16V,GP,TP,6.3x7,5	1	SA	
C1P118	2203-000206	C-CER,CHIP;100nF,10%,50V,X7R,TP,201	1	SA							
C1P119	2203-000206	C-CER,CHIP;100nF,10%,50V,X7R,TP,201	1	SA		FC9	2203-005249	C-CER,CHIP;100nF,10%,50V,X7R,TP,160	1	SA	
C1P120	2203-005171	C-CER,CHIP;1000nF,10%,16V,X7R,2012	1	SA		FCW1	3708-000411	CONNECTOR-FPC/FFC/PIC;12P,1.25mm,ST	1	SA	
C1P121	2203-000206	C-CER,CHIP;100nF,10%,50V,X7R,TP,201	1	SA		FCW3	3708-000303	CONNECTOR-FPC/FFC/PIC;6P,1.25mm,STR	1	SA	
C1P93	2202-000173	C-CERAMIC,MLC-AXIAL;1nF,10%,50V,Y5P	1	SA		FD1	0401-001099	DIODE-SWITCHING;1N4148WS,75V,150mA,	1	SA	
						FD2	0401-001099	DIODE-SWITCHING;1N4148WS,75V,150mA,	1	SA	
C1P94	2203-000440	C-CER,CHIP;1nF,10%,50V,X7R,1608	1	SA							

Exploded View & Part List

Loc. No.	Part No.	Description;Specification	Q'ty	SNA	Remark	Loc. No.	Part No.	Description;Specification	Q'ty	SNA	Remark
						HR17	2007-000124	R-CHIP;2.2Kohm,5%,1/10W,TP,1608	1	SA	
						HR18	2007-000124	R-CHIP;2.2Kohm,5%,1/10W,TP,1608	1	SA	
FD3	0403-001170	DIODE-ZENER;MTZJ9.1C,8.89-9.29V,500	1	SA							
FD4	0401-001099	DIODE-SWITCHING;1N4148WS,75V,150mA,	1	SA							
FD5	0401-001099	DIODE-SWITCHING;1N4148WS,75V,150mA,	1	SA		HR19	2007-000102	R-CHIP;100Kohm,5%,1/10W,TP,1608	1	SA	
FIC1	1204-002518	IC-VOLUME/TONE CONT.;R2S15904SP,SOP	1	SA		HR20	2007-000102	R-CHIP;100Kohm,5%,1/10W,TP,1608	1	SA	
FIC2	1201-000163	IC-OP AMP;4560,SOP8P,173MIL,DUAL,1	1	SA		HR21	2001-000449	R-CARBON;2.2Kohm,5%,1/8W,AA,TP,1.8x	1	SA	
						HR22	2001-000062	R-CARBON;470ohm,5%,1/4W,AA,TP,2.4x6	1	SA	
FLASH	AH94-02237T	ASSY-NOR FLASH;HT-Z420,MX25L1605A,M	1	SNA		HR4	2001-000062	R-CARBON;470ohm,5%,1/4W,AA,TP,2.4x6	1	SA	
FR10	2001-000281	R-CARBON;100ohm,5%,1/8W,AA,TP,1.8x3	1	SA							
FR11	2001-000281	R-CARBON;100ohm,5%,1/8W,AA,TP,1.8x3	1	SA		HR5	2007-000312	R-CHIP;10ohm,5%,1/4W,TP,3216	1	SA	
FR12	2007-000091	R-CHIP;12Kohm,5%,1/10W,TP,1608	1	SA		HR6	2007-000092	R-CHIP;15Kohm,5%,1/10W,TP,1608	1	SA	
FR13	2007-000091	R-CHIP;12Kohm,5%,1/10W,TP,1608	1	SA		HR7	2007-000092	R-CHIP;15Kohm,5%,1/10W,TP,1608	1	SA	
						HR8	2007-000312	R-CHIP;10ohm,5%,1/4W,TP,3216	1	SA	
FR14	2001-000027	R-CARBON;100ohm,5%,1/4W,AA,TP,2.4x6	1	SA		HR9	2007-000086	R-CHIP;5.6Kohm,5%,1/10W,TP,1608	1	SA	
FR15	2007-000092	R-CHIP;15Kohm,5%,1/10W,TP,1608	1	SA							
FR16	2007-000130	R-CHIP;39Kohm,5%,1/10W,TP,1608	1	SA		HZ1	0403-000355	DIODE-ZENER;UZ5.1BSB,5-5.2V,500MW,D	1	SA	
FR17	2007-000130	R-CHIP;39Kohm,5%,1/10W,TP,1608	1	SA		IC1P101	1203-004520	IC-DC/DC CONVERTER;AP1501,TO-220(R)	1	SA	
FR18	2007-000129	R-CHIP;27Kohm,5%,1/10W,TP,1608	1	SA		IC1P101/102 HS	AH62-00194B	HEAT SINK;MAX-G55,AL,3,35,15,EXP,10	2	SA	
						IC1P102	1203-004520	IC-DC/DC CONVERTER;AP1501,TO-220(R)	1	SA	
FR19	2007-000097	R-CHIP;47Kohm,5%,1/10W,TP,1608	1	SA		IC1P103	1203-005188	IC-DC/DC CONVERTER;AOZ1021A1L,SOP,8	1	SA	
FR20	2007-000097	R-CHIP;47Kohm,5%,1/10W,TP,1608	1	SA							
FR21	2001-000563	R-CARBON;27Kohm,5%,1/8W,AA,TP,1.8x3	1	SA		IC1P104	0505-001170	FET-SILICON;SI9933ADY-T1,P,-20V,3.4	1	SA	
FR22	2001-000027	R-CARBON;100ohm,5%,1/4W,AA,TP,2.4x6	1	SA		JCW3	3708-000249	CONNECTOR-FPC/FFC/PIC;27P,1.25mm,ST	1	SA	
FR28	2001-000281	R-CARBON;100ohm,5%,1/8W,AA,TP,1.8x3	1	SA		JCW4	3711-001038	HEADER-BOARD TO CABLE;BOX,6P,1R,2.5	1	SA	
						JX1	3811-001868	WIRE-NO SHEATH CU;SnCuFe,52mm,GRY	1	SA	
FR29	2001-000281	R-CARBON;100ohm,5%,1/8W,AA,TP,1.8x3	1	SA		JX2	3811-001868	WIRE-NO SHEATH CU;SnCuFe,52mm,GRY	1	SA	
FR3	2007-000293	R-CHIP;100ohm,5%,1/4W,TP,3216	1	SA							
FR4	2001-000010	R-CARBON;68Kohm,5%,1/8W,AA,TP,1.8x3	1	SA		JX5	3811-001868	WIRE-NO SHEATH CU;SnCuFe,52mm,GRY	1	SA	
FR5	2001-000010	R-CARBON;68Kohm,5%,1/8W,AA,TP,1.8x3	1	SA		JX6	3811-001868	WIRE-NO SHEATH CU;SnCuFe,52mm,GRY	1	SA	
FR8	2007-000458	R-CHIP;18Kohm,5%,1/10W,TP,1608	1	SA		L1P101	AH27-00062A	COIL FILTER;HXD77.22.8uH,55mOHM,19.	1	SA	
						L1P102	AH27-00062A	COIL FILTER;HXD77.22.8uH,55mOHM,19.	1	SA	
FR9	2007-000458	R-CHIP;18Kohm,5%,1/10W,TP,1608	1	SA		L1P103	AH27-00055A	COIL CHOKE;DBF-1310A,HT-DS600,10uH,	1	SA	
H/S PAD	AH73-00131A	RUBBER-SILICON;MAX-DA55,GAP PAD 150	1	SA							
H/S-BRACKET	AH61-02549A	BRACKET-PCB;MM-DA25,SECC 1.0T,1.0,	1	SA		L1P104	AH27-10001F	COIL-CHOKE;K,Q30,0.65,DR(6.5*7.5),2	1	SA	
HC1	2401-000042	C-AL;100uF,20%,16V,GP,TP,6.3x7,5	1	SA		L1P105	3301-000297	BEAD-AXIAL;25ohm,3.6x1.2x5.7mm,-,TP	1	SA	
HC10	2401-001508	C-AL;47uF,20%,16V,GP,TP,6.3x5,5	1	SA		L1S30	AH27-00062A	COIL FILTER;HXD77.22.8uH,55mOHM,19.	1	SA	
						L1S31	AH27-00062A	COIL FILTER;HXD77.22.8uH,55mOHM,19.	1	SA	
HC11	2203-001596	C-CER,CHIP;2200nF,+80-20%,50V,Y5V,2	1	SA		NEW1	2007-000070	R-CHIP;0ohm,5%,1/10W,TP,1608	1	SA	
HC12	2203-001596	C-CER,CHIP;2200nF,+80-20%,50V,Y5V,2	1	SA							
HC13	2203-001596	C-CER,CHIP;2200nF,+80-20%,50V,Y5V,2	1	SA		NEW2	3811-001868	WIRE-NO SHEATH CU;SnCuFe,52mm,GRY	1	SA	
HC14	2203-001596	C-CER,CHIP;2200nF,+80-20%,50V,Y5V,2	1	SA		NEW3	2001-000281	R-CARBON;100ohm,5%,1/8W,AA,TP,1.8x3	1	SA	
HC15	2401-001092	C-AL;330uF,20%,10V,GP,-,8x11.5,2.5m	1	SA		NEW4	2001-000281	R-CARBON;100ohm,5%,1/8W,AA,TP,1.8x3	1	SA	
						NEW5	2001-000281	R-CARBON;100ohm,5%,1/8W,AA,TP,1.8x3	1	SA	
HC2	2401-000042	C-AL;100uF,20%,16V,GP,TP,6.3x7,5	1	SA		PCB	AH41-01214A	PCB-MAIN;MM-DG25,KH,1,0,T1.6,247*24	1	SNA	
HC3	2401-000042	C-AL;100uF,20%,16V,GP,TP,6.3x7,5	1	SA							
HC6	2203-001607	C-CER,CHIP;0.22nF,5%,50V,NP0,1608	1	SA		PJW601	3301-000297	BEAD-AXIAL;25ohm,3.6x1.2x5.7mm,-,TP	1	SA	
HC7	2203-001607	C-CER,CHIP;0.22nF,5%,50V,NP0,1608	1	SA		PJW603	3301-000297	BEAD-AXIAL;25ohm,3.6x1.2x5.7mm,-,TP	1	SA	
HC8	2203-001596	C-CER,CHIP;2200nF,+80-20%,50V,Y5V,2	1	SA		PJW604	2007-000033	R-CHIP;0ohm,5%,1/4W,TP,3216	1	SA	
						PJW606	3811-001868	WIRE-NO SHEATH CU;SnCuFe,52mm,GRY	1	SA	
HC9	2203-001596	C-CER,CHIP;2200nF,+80-20%,50V,Y5V,2	1	SA		PT01	AH26-00363A	TRANS SWITCHING;EER-3541,MAX-DG25,1	1	SA	
HD1	0401-000005	DIODE-SWITCHING;1N4148,75V,150mA,DO	1	SA							
HIC2	1201-000163	IC-OP AMP;4560,SOP8P,173MIL,DUAL,1	1	SA		Q1P101	0501-000010	TR-SMALL SIGNAL;KSC1008,NPN,800mW,T	1	SA	
HMD	AH63-01947A	ABSORBER EVAP-EVA SHEET;MM-DG25,CUS	1	SNA		Q1P102	0504-000152	TR-DIGITAL;KSR2101,PNP,200mW,4.7K/4	1	SA	
HQ1	0501-000341	TR-SMALL SIGNAL;KSC1623-L,NPN,200mW	1	SA		Q1P103	0504-000152	TR-DIGITAL;KSR2101,PNP,200mW,4.7K/4	1	SA	
						Q1P104	0501-000010	TR-SMALL SIGNAL;KSC1008,NPN,800mW,T	1	SA	
HQ2	0504-000156	TR-DIGITAL;KSR2103,PNP,200MW,22K/22	1	SA		Q1P105	0504-000128	TR-DIGITAL;-NPN,200MW,22K/22K,SOT-	1	SA	
HQ3	0501-000341	TR-SMALL SIGNAL;KSC1623-L,NPN,200mW	1	SA							
HQ4	0501-000341	TR-SMALL SIGNAL;KSC1623-L,NPN,200mW	1	SA		Q1P106	0504-000152	TR-DIGITAL;KSR2101,PNP,200mW,4.7K/4	1	SA	
HQ5	0501-000341	TR-SMALL SIGNAL;KSC1623-L,NPN,200mW	1	SA		Q1P107	0501-000369	TR-SMALL SIGNAL;KSC2331-Y,NPN,1000m	1	SA	
HQ6	0504-000156	TR-DIGITAL;KSR2103,PNP,200MW,22K/22	1	SA		Q1P108	0504-000152	TR-DIGITAL;KSR2101,PNP,200mW,4.7K/4	1	SA	
						Q1P109	0501-000010	TR-SMALL SIGNAL;KSC1008,NPN,800mW,T	1	SA	
HR1	2001-000062	R-CARBON;470ohm,5%,1/4W,AA,TP,2.4x6	1	SA		Q1P110	0504-000128	TR-DIGITAL;-NPN,200MW,22K/22K,SOT-	1	SA	
HR10	2007-000086	R-CHIP;5.6Kohm,5%,1/10W,TP,1608	1	SA							
HR11	2007-000134	R-CHIP;33Kohm,5%,1/10W,TP,1608	1	SA		Q1S02	0505-001667	FET-SILICON;SPA07N60C3,N,600V,4.3A,	1	SA	
HR12	2007-000134	R-CHIP;33Kohm,5%,1/10W,TP,1608	1	SA		Q1S02 H/S	AH62-30122A	HEAT SINK-POWER;1,AL,VO,T1.3,ANODIZ	1	SA	
HR13	2001-000802	R-CARBON;5.6Kohm,5%,1/8W,AA,TP,1.8x	1	SA		Q1S90	0501-000341	TR-SMALL SIGNAL;KSC1623-L,NPN,200mW	1	SA	
						R1	2007-000078	R-CHIP;1Kohm,5%,1/10W,TP,1608	1	SA	
HR14	2001-000802	R-CARBON;5.6Kohm,5%,1/8W,AA,TP,1.8x	1	SA		R1P100	2001-000429	R-CARBON;1Kohm,5%,1/8W,AA,TP,1.8x3.	1	SA	
HR15	2007-000124	R-CHIP;2.2Kohm,5%,1/10W,TP,1608	1	SA							
HR16	2007-000124	R-CHIP;2.2Kohm,5%,1/10W,TP,1608	1	SA		R1P101	2007-000090	R-CHIP;10Kohm,5%,1/10W,TP,1608	1	SA	

Loc. No.	Part No.	Description;Specification	Q'ty	SNA	Remark	Loc. No.	Part No.	Description;Specification	Q'ty	SNA	Remark
R1P102	2007-000124	R-CHIP;2.2Kohm,5%,1/10W,TP,1608	1	SA							
R1P103	2007-000078	R-CHIP;1Kohm,5%,1/10W,TP,1608	1	SA		UB9	3301-000297	BEAD-AXIAL;25ohm,3.6x1.2x5.7mm,-,TP	1	SA	
R1P104	3811-001868	WIRE-NO SHEATH CU;SnCuFe,52mm,GRY	1	SA		UC1	2203-005148	C-CER,CHIP;100nF,10%,16V,X7R,TP,160	1	SA	
R1P105	2007-000134	R-CHIP;33Kohm,5%,1/10W,TP,1608	1	SA		UC10	2203-005148	C-CER,CHIP;100nF,10%,16V,X7R,TP,160	1	SA	
						UC11	2401-000042	C-AL;100uF,20%,16V,GP,TP,6.3x7.5	1	SA	
						UC12	2203-005148	C-CER,CHIP;100nF,10%,16V,X7R,TP,160	1	SA	
R1P106	2007-000962	R-CHIP;5.1Kohm,1%,1/10W,TP,1608	1	SA							
R1P107	2001-000802	R-CARBON;5.6Kohm,5%,1/8W,AA,TP,1.8x	1	SA		UC13	2203-005148	C-CER,CHIP;100nF,10%,16V,X7R,TP,160	1	SA	
R1P108	2007-000130	R-CHIP;39Kohm,5%,1/10W,TP,1608	1	SA		UC2	2203-000626	C-CER,CHIP;0.022nF,5%,50V,COG,1608	1	SA	
R1P109	2007-000962	R-CHIP;5.1Kohm,1%,1/10W,TP,1608	1	SA		UC3	2203-001596	C-CER,CHIP;2200nF,+80-20%,50V,Y5V,2	1	SA	
R1P110	2001-000411	R-CARBON;18Kohm,5%,1/8W,AA,TP,1.8x3	1	SA		UC4	2203-001596	C-CER,CHIP;2200nF,+80-20%,50V,Y5V,2	1	SA	
						UC5	2203-000626	C-CER,CHIP;0.022nF,5%,50V,COG,1608	1	SA	
R1P111	2007-000093	R-CHIP;20Kohm,5%,1/10W,TP,1608	1	SA							
R1P112	2007-000090	R-CHIP;10Kohm,5%,1/10W,TP,1608	1	SA		UC6	2401-000759	C-AL;220nF,20%,50V,GP,TP,5x11mm,5mm	1	SA	
R1P113	2007-000084	R-CHIP;4.7Kohm,5%,1/10W,TP,1608	1	SA		UC7	2203-005148	C-CER,CHIP;100nF,10%,16V,X7R,TP,160	1	SA	
R1P114	2007-000129	R-CHIP;27Kohm,5%,1/10W,TP,1608	1	SA		UC8	2401-000042	C-AL;100uF,20%,16V,GP,TP,6.3x7.5	1	SA	
R1P115	2007-000097	R-CHIP;47Kohm,5%,1/10W,TP,1608	1	SA		UC9	2401-003010	C-AL;1000uF,20%,6.3V,GP,TP,8x11.5mm	1	SA	
						UD1	0401-000005	DIODE-SWITCHING;1N4148,75V,150mA,DO	1	SA	
R1P116	2007-000097	R-CHIP;47Kohm,5%,1/10W,TP,1608	1	SA		UD2	0401-000005	DIODE-SWITCHING;1N4148,75V,150mA,DO	1	SA	
R1P117	2001-001178	R-CARBON(S);680ohm,5%,1/2W,AA,TP,2.	1	SA		UD3	0401-000005	DIODE-SWITCHING;1N4148,75V,150mA,DO	1	SA	
R1P118	2007-000090	R-CHIP;10Kohm,5%,1/10W,TP,1608	1	SA		UD4	0401-000005	DIODE-SWITCHING;1N4148,75V,150mA,DO	1	SA	
R1P119	2007-000084	R-CHIP;5.7Kohm,5%,1/10W,TP,1608	1	SA		UD5	0401-000005	DIODE-SWITCHING;1N4148,75V,150mA,DO	1	SA	
R1P120	2007-000070	R-CHIP;0ohm,5%,1/10W,TP,1608	1	SA		UIC1	0903-001565	IC-MICROCONTROLLER;LC87F5NC8AVU,QFP	1	SA	
R1P121	2007-000124	R-CHIP;2.2Kohm,5%,1/10W,TP,1608	1	SA							
R1P122	2001-000065	R-CARBON;10Kohm,5%,1/4W,AA,TP,2.4x6	1	SA		UIC2	1103-001333	IC-EEPROM;24C08A,8Kbit,1Kx8,SOP,8P,	1	SA	
R1P123	2001-001178	R-CARBON(S);680ohm,5%,1/2W,AA,TP,2.	1	SA		UIC2	1103-001333	IC-EEPROM;24C08A,8Kbit,1Kx8,SOP,8P,	1	SA	
R1P124	2007-000124	R-CHIP;2.2Kohm,5%,1/10W,TP,1608	1	SA		UQ1	0501-000341	TR-SMALL SIGNAL;KSC1623-L,NPN,200mW	1	SA	
R1P125	2001-000009	R-CARBON;20Kohm,5%,1/8W,AA,TP,1.8x3	1	SA		UR1	2001-000281	R-CARBON;100ohm,5%,1/8W,AA,TP,1.8x3	1	SA	
						UR10	2007-000076	R-CHIP;330ohm,5%,1/10W,TP,1608	1	SA	
R1P126	3811-001868	WIRE-NO SHEATH CU;SnCuFe,52mm,GRY	1	SA							
R1P127	2001-000052	R-CARBON(S);3.3Kohm,5%,1/2W,AA,TP,2	1	SA		UR11	2001-000281	R-CARBON;100ohm,5%,1/8W,AA,TP,1.8x3	1	SA	
R1P128	3811-001868	WIRE-NO SHEATH CU;SnCuFe,52mm,GRY	1	SA		UR12	2001-000281	R-CARBON;100ohm,5%,1/8W,AA,TP,1.8x3	1	SA	
R1P142	2007-000824	R-CHIP;390ohm,5%,1/4W,TP,3216	1	SA		UR13	2001-000281	R-CARBON;100ohm,5%,1/8W,AA,TP,1.8x3	1	SA	
R1P98	2007-000090	R-CHIP;10Kohm,5%,1/10W,TP,1608	1	SA		UR14	2007-000090	R-CHIP;10Kohm,5%,1/10W,TP,1608	1	SA	
						UR15	2001-000429	R-CARBON;1Kohm,5%,1/8W,AA,TP,1.8x3.	1	SA	
R1P99	2001-000429	R-CARBON;1Kohm,5%,1/8W,AA,TP,1.8x3.	1	SA		UR16	2001-000786	R-CARBON;47Kohm,5%,1/8W,AA,TP,1.8x3	1	SA	
R1S01	2002-000121	R-COMPOSITION;1Mohm,10%,1/2W,AA,TP,	1	SA		UR17	2001-000666	R-CARBON;33ohm,5%,1/8W,AA,TP,1.8x3.	1	SA	
R1S30	2008-000003	R-FUSIBLE;0.22ohm,5%,1/2W,AA,TP,3.5	1	SA		UR18	2001-000666	R-CARBON;33ohm,5%,1/8W,AA,TP,1.8x3.	1	SA	
R1S33	2007-000078	R-CHIP;1Kohm,5%,1/10W,TP,1608	1	SA		UR19	2001-000666	R-CARBON;33ohm,5%,1/8W,AA,TP,1.8x3.	1	SA	
R1S34	2007-000965	R-CHIP;5.1Kohm,5%,1/10W,TP,1608	1	SA		UR2	2001-000281	R-CARBON;100ohm,5%,1/8W,AA,TP,1.8x3	1	SA	
						UR20	2001-000281	R-CARBON;100ohm,5%,1/8W,AA,TP,1.8x3	1	SA	
R1S35	2007-001175	R-CHIP;8.2Kohm,1%,1/10W,TP,1608	1	SA		UR21	2001-000281	R-CARBON;100ohm,5%,1/8W,AA,TP,1.8x3	1	SA	
R1S36	2007-000124	R-CHIP;2.2Kohm,5%,1/10W,TP,1608	1	SA		UR22	2007-000305	R-CHIP;10Mohm,5%,1/10W,TP,1608	1	SA	
R1S37	2007-000772	R-CHIP;33Kohm,1%,1/10W,TP,1608	1	SA		UR23	2001-000281	R-CARBON;100ohm,5%,1/8W,AA,TP,1.8x3	1	SA	
R1S38	2007-000106	R-CHIP;220Kohm,5%,1/10W,TP,1608	1	SA		UR24	2001-000281	R-CARBON;100ohm,5%,1/8W,AA,TP,1.8x3	1	SA	
SCREW	6003-001375	SCREW-TAPTYPE;BH,+,-,B,M3,L8,ZPC(WH)	7	SNA							
						UR25	2007-001026	R-CHIP;560Kohm,5%,1/10W,TP,1608	1	SA	
TB1	3301-001495	BEAD-SMD;120ohm,2012,2500mA,TP,115o	1	SA		UR26	2001-000449	R-CARBON;2.2Kohm,5%,1/8W,AA,TP,1.8x	1	SA	
TC1	2203-001596	C-CER,CHIP;2200nF,+80-20%,50V,Y5V,2	1	SA		UR27	2007-000084	R-CHIP;4.7Kohm,5%,1/10W,TP,1608	1	SA	
TC2	2203-001596	C-CER,CHIP;2200nF,+80-20%,50V,Y5V,2	1	SA		UR28	2007-000109	R-CHIP;1Mohm,5%,1/10W,TP,1608	1	SA	
TC3	2203-005249	C-CER,CHIP;100nF,10%,50V,X7R,TP,160	1	SA		UR29	2007-000402	R-CHIP;150ohm,5%,1/10W,TP,1608	1	SA	
TC4	2401-001092	C-AL;330uF,20%,10V,GP,-,8x11.5,2.5m	1	SA							
						UR3	2001-000281	R-CARBON;100ohm,5%,1/8W,AA,TP,1.8x3	1	SA	
TC5	2203-000440	C-CER,CHIP;1nF,10%,50V,X7R,1608	1	SA		UR30	2007-000106	R-CHIP;220Kohm,5%,1/10W,TP,1608	1	SA	
TC6	2203-000440	C-CER,CHIP;1nF,10%,50V,X7R,1608	1	SA		UR31	2001-000429	R-CARBON;1Kohm,5%,1/8W,AA,TP,1.8x3.	1	SA	
TR1	2007-000130	R-CHIP;39Kohm,5%,1/10W,TP,1608	1	SA		UR32	2001-000290	R-CARBON;10Kohm,5%,1/8W,AA,TP,1.8x3	1	SA	
TR2	2007-000130	R-CHIP;39Kohm,5%,1/10W,TP,1608	1	SA		UR33	2007-000402	R-CHIP;150ohm,5%,1/10W,TP,1608	1	SA	
TR3	2001-000411	R-CARBON;18Kohm,5%,1/8W,AA,TP,1.8x3	1	SA							
						UR34	2007-000090	R-CHIP;10Kohm,5%,1/10W,TP,1608	1	SA	
TR4	2001-000411	R-CARBON;18Kohm,5%,1/8W,AA,TP,1.8x3	1	SA		UR35	2001-000281	R-CARBON;100ohm,5%,1/8W,AA,TP,1.8x3	1	SA	
TR5	2001-000281	R-CARBON;100ohm,5%,1/8W,AA,TP,1.8x3	1	SA		UR36	2001-000290	R-CARBON;10Kohm,5%,1/8W,AA,TP,1.8x3	1	SA	
TR6	2001-000281	R-CARBON;100ohm,5%,1/8W,AA,TP,1.8x3	1	SA		UR37	2007-000090	R-CHIP;10Kohm,5%,1/10W,TP,1608	1	SA	
TR7	2001-000429	R-CARBON;1Kohm,5%,1/8W,AA,TP,1.8x3.	1	SA		UR38	2007-000090	R-CHIP;10Kohm,5%,1/10W,TP,1608	1	SA	
TUNER	AH40-00151A	TUNER-MODULE;KST-MW000FV0-S58,MAX-D	1	SA							
						UR39	2007-000094	R-CHIP;22Kohm,5%,1/10W,TP,1608	1	SA	
UB1	3301-001495	BEAD-SMD;120ohm,2012,2500mA,TP,115o	1	SA		UR4	2001-000281	R-CARBON;100ohm,5%,1/8W,AA,TP,1.8x3	1	SA	
UB3	3301-001495	BEAD-SMD;120ohm,2012,2500mA,TP,115o	1	SA		UR40	2001-000290	R-CARBON;10Kohm,5%,1/8W,AA,TP,1.8x3	1	SA	
UB4	2007-000029	R-CHIP;0ohm,5%,1/8W,TP,2012	1	SA							
UB5	3301-001495	BEAD-SMD;120ohm,2012,2500mA,TP,115o	1	SA							
UB8	3301-001495	BEAD-SMD;120ohm,2012,2500mA,TP,115o	1	SA							

Exploded View & Part List

Loc. No.	Part No.	Description;Specification	Q'ty	SNA	Remark	Loc. No.	Part No.	Description;Specification	Q'ty	SNA	Remark
UR41	2001-000281	R-CARBON;100ohm,5%,1/8W,AA,TP,1.8x3	1	SA		W147	3811-001868	WIRE-NO SHEATH CU;SnCuFe,52mm,GRY	1	SA	
UR42	2001-000281	R-CARBON;100ohm,5%,1/8W,AA,TP,1.8x3	1	SA		W148	3811-001868	WIRE-NO SHEATH CU;SnCuFe,52mm,GRY	1	SA	
UR43	2001-000281	R-CARBON;100ohm,5%,1/8W,AA,TP,1.8x3	1	SA		W149	3811-001868	WIRE-NO SHEATH CU;SnCuFe,52mm,GRY	1	SA	
UR44	2007-000097	R-CHIP;47Kohm,5%,1/10W,TP,1608	1	SA		W150	3811-001868	WIRE-NO SHEATH CU;SnCuFe,52mm,GRY	1	SA	
UR47	2007-000087	R-CHIP;6.8Kohm,5%,1/10W,TP,1608	1	SA		W151	3811-001868	WIRE-NO SHEATH CU;SnCuFe,52mm,GRY	1	SA	
UR48	2007-000084	R-CHIP;4.7Kohm,5%,1/10W,TP,1608	1	SA		W152	3811-001868	WIRE-NO SHEATH CU;SnCuFe,52mm,GRY	1	SA	
UR49	2001-000429	R-CARBON;1Kohm,5%,1/8W,AA,TP,1.8x3.	1	SA		W153	3811-001868	WIRE-NO SHEATH CU;SnCuFe,52mm,GRY	1	SA	
UR5	2007-000102	R-CHIP;100Kohm,5%,1/10W,TP,1608	1	SA		W154	3811-001868	WIRE-NO SHEATH CU;SnCuFe,52mm,GRY	1	SA	
UR6	2007-000102	R-CHIP;100Kohm,5%,1/10W,TP,1608	1	SA		W155	3811-001868	WIRE-NO SHEATH CU;SnCuFe,52mm,GRY	1	SA	
UR7	2007-000102	R-CHIP;100Kohm,5%,1/10W,TP,1608	1	SA		W156	3811-001868	WIRE-NO SHEATH CU;SnCuFe,52mm,GRY	1	SA	
UR8	2007-000076	R-CHIP;330ohm,5%,1/10W,TP,1608	1	SA		W157	3811-001868	WIRE-NO SHEATH CU;SnCuFe,52mm,GRY	1	SA	
UR9	2007-000076	R-CHIP;330ohm,5%,1/10W,TP,1608	1	SA		W158	3811-001868	WIRE-NO SHEATH CU;SnCuFe,52mm,GRY	1	SA	
VA1S01	1405-000186	VARISTOR;470V,2500A,17.5x7.5mm,TP	1	SA		W159	3811-001868	WIRE-NO SHEATH CU;SnCuFe,52mm,GRY	1	SA	
VL6	3301-001495	BEAD-SMD;120ohm,2012,2500mA,TP,115o	1	SA		W160	3811-001868	WIRE-NO SHEATH CU;SnCuFe,52mm,GRY	1	SA	
W101	3811-001868	WIRE-NO SHEATH CU;SnCuFe,52mm,GRY	1	SA		W161	3811-001868	WIRE-NO SHEATH CU;SnCuFe,52mm,GRY	1	SA	
W102	3811-001868	WIRE-NO SHEATH CU;SnCuFe,52mm,GRY	1	SA		W162	3811-001868	WIRE-NO SHEATH CU;SnCuFe,52mm,GRY	1	SA	
W103	3811-001868	WIRE-NO SHEATH CU;SnCuFe,52mm,GRY	1	SA		W163	3811-001868	WIRE-NO SHEATH CU;SnCuFe,52mm,GRY	1	SA	
W104	3811-001868	WIRE-NO SHEATH CU;SnCuFe,52mm,GRY	1	SA		W164	3811-001868	WIRE-NO SHEATH CU;SnCuFe,52mm,GRY	1	SA	
W105	3811-001868	WIRE-NO SHEATH CU;SnCuFe,52mm,GRY	1	SA		W165	3811-001868	WIRE-NO SHEATH CU;SnCuFe,52mm,GRY	1	SA	
W106	3811-001868	WIRE-NO SHEATH CU;SnCuFe,52mm,GRY	1	SA		W166	3811-001868	WIRE-NO SHEATH CU;SnCuFe,52mm,GRY	1	SA	
W107	3811-001868	WIRE-NO SHEATH CU;SnCuFe,52mm,GRY	1	SA		W167	3811-001868	WIRE-NO SHEATH CU;SnCuFe,52mm,GRY	1	SA	
W108	3811-001868	WIRE-NO SHEATH CU;SnCuFe,52mm,GRY	1	SA		W168	3811-001868	WIRE-NO SHEATH CU;SnCuFe,52mm,GRY	1	SA	
W109	3811-001868	WIRE-NO SHEATH CU;SnCuFe,52mm,GRY	1	SA		W169	3811-001868	WIRE-NO SHEATH CU;SnCuFe,52mm,GRY	1	SA	
W110	3811-001868	WIRE-NO SHEATH CU;SnCuFe,52mm,GRY	1	SA		W170	3811-001868	WIRE-NO SHEATH CU;SnCuFe,52mm,GRY	1	SA	
W111	3811-001868	WIRE-NO SHEATH CU;SnCuFe,52mm,GRY	1	SA		W171	3811-001868	WIRE-NO SHEATH CU;SnCuFe,52mm,GRY	1	SA	
W112	3811-001868	WIRE-NO SHEATH CU;SnCuFe,52mm,GRY	1	SA		W172	3811-001868	WIRE-NO SHEATH CU;SnCuFe,52mm,GRY	1	SA	
W113	3811-001868	WIRE-NO SHEATH CU;SnCuFe,52mm,GRY	1	SA		W173	3811-001868	WIRE-NO SHEATH CU;SnCuFe,52mm,GRY	1	SA	
W114	3301-000297	BEAD-AXIAL;25ohm,3.6x1.2x5.7mm,-,TP	1	SA		W174	3811-001868	WIRE-NO SHEATH CU;SnCuFe,52mm,GRY	1	SA	
W115	3301-000297	BEAD-AXIAL;25ohm,3.6x1.2x5.7mm,-,TP	1	SA		W175	3811-001868	WIRE-NO SHEATH CU;SnCuFe,52mm,GRY	1	SA	
W116	3811-001868	WIRE-NO SHEATH CU;SnCuFe,52mm,GRY	1	SA		W176	3811-001868	WIRE-NO SHEATH CU;SnCuFe,52mm,GRY	1	SA	
W117	3811-001868	WIRE-NO SHEATH CU;SnCuFe,52mm,GRY	1	SA		W177	3811-001868	WIRE-NO SHEATH CU;SnCuFe,52mm,GRY	1	SA	
W118	3811-001868	WIRE-NO SHEATH CU;SnCuFe,52mm,GRY	1	SA		W178	3811-001868	WIRE-NO SHEATH CU;SnCuFe,52mm,GRY	1	SA	
W119	3811-001868	WIRE-NO SHEATH CU;SnCuFe,52mm,GRY	1	SA		W179	3811-001868	WIRE-NO SHEATH CU;SnCuFe,52mm,GRY	1	SA	
W120	3811-001868	WIRE-NO SHEATH CU;SnCuFe,52mm,GRY	1	SA		W180	3811-001868	WIRE-NO SHEATH CU;SnCuFe,52mm,GRY	1	SA	
W121	3811-001868	WIRE-NO SHEATH CU;SnCuFe,52mm,GRY	1	SA		W181	2001-000281	R-CARBON;100ohm,5%,1/8W,AA,TP,1.8x3	1	SA	
W122	3811-001868	WIRE-NO SHEATH CU;SnCuFe,52mm,GRY	1	SA		W182	3811-001868	WIRE-NO SHEATH CU;SnCuFe,52mm,GRY	1	SA	
W123	3811-001868	WIRE-NO SHEATH CU;SnCuFe,52mm,GRY	1	SA		W183	3811-001868	WIRE-NO SHEATH CU;SnCuFe,52mm,GRY	1	SA	
W124	3811-001868	WIRE-NO SHEATH CU;SnCuFe,52mm,GRY	1	SA		W184	3811-001868	WIRE-NO SHEATH CU;SnCuFe,52mm,GRY	1	SA	
W125	3301-000297	BEAD-AXIAL;25ohm,3.6x1.2x5.7mm,-,TP	1	SA		W185	3811-001868	WIRE-NO SHEATH CU;SnCuFe,52mm,GRY	1	SA	
W126	3811-001868	WIRE-NO SHEATH CU;SnCuFe,52mm,GRY	1	SA		W186	3811-001868	WIRE-NO SHEATH CU;SnCuFe,52mm,GRY	1	SA	
W127	3811-001868	WIRE-NO SHEATH CU;SnCuFe,52mm,GRY	1	SA		W187	3811-001868	WIRE-NO SHEATH CU;SnCuFe,52mm,GRY	1	SA	
W128	3811-001868	WIRE-NO SHEATH CU;SnCuFe,52mm,GRY	1	SA		W188	3811-001868	WIRE-NO SHEATH CU;SnCuFe,52mm,GRY	1	SA	
W129	3811-001868	WIRE-NO SHEATH CU;SnCuFe,52mm,GRY	1	SA		W189	3811-001868	WIRE-NO SHEATH CU;SnCuFe,52mm,GRY	1	SA	
W130	3811-001868	WIRE-NO SHEATH CU;SnCuFe,52mm,GRY	1	SA		W190	3811-001868	WIRE-NO SHEATH CU;SnCuFe,52mm,GRY	1	SA	
W131	3811-001868	WIRE-NO SHEATH CU;SnCuFe,52mm,GRY	1	SA		W191	3811-001868	WIRE-NO SHEATH CU;SnCuFe,52mm,GRY	1	SA	
W132	3811-001868	WIRE-NO SHEATH CU;SnCuFe,52mm,GRY	1	SA		W192	3811-001868	WIRE-NO SHEATH CU;SnCuFe,52mm,GRY	1	SA	
W133	3811-001868	WIRE-NO SHEATH CU;SnCuFe,52mm,GRY	1	SA		W193	3811-001868	WIRE-NO SHEATH CU;SnCuFe,52mm,GRY	1	SA	
W136	3811-001868	WIRE-NO SHEATH CU;SnCuFe,52mm,GRY	1	SA		W194	3811-001868	WIRE-NO SHEATH CU;SnCuFe,52mm,GRY	1	SA	
W137	3811-001868	WIRE-NO SHEATH CU;SnCuFe,52mm,GRY	1	SA		W195	3811-001868	WIRE-NO SHEATH CU;SnCuFe,52mm,GRY	1	SA	
W138	3811-001868	WIRE-NO SHEATH CU;SnCuFe,52mm,GRY	1	SA		W196	3811-001868	WIRE-NO SHEATH CU;SnCuFe,52mm,GRY	1	SA	
W139	3811-001868	WIRE-NO SHEATH CU;SnCuFe,52mm,GRY	1	SA		W197	3811-001868	WIRE-NO SHEATH CU;SnCuFe,52mm,GRY	1	SA	
W140	3811-001868	WIRE-NO SHEATH CU;SnCuFe,52mm,GRY	1	SA		W198	3811-001868	WIRE-NO SHEATH CU;SnCuFe,52mm,GRY	1	SA	
W141	3811-001868	WIRE-NO SHEATH CU;SnCuFe,52mm,GRY	1	SA		W199	3811-001868	WIRE-NO SHEATH CU;SnCuFe,52mm,GRY	1	SA	
W142	3811-001868	WIRE-NO SHEATH CU;SnCuFe,52mm,GRY	1	SA		W200	3811-001868	WIRE-NO SHEATH CU;SnCuFe,52mm,GRY	1	SA	
W143	3811-001868	WIRE-NO SHEATH CU;SnCuFe,52mm,GRY	1	SA		W201	3811-001868	WIRE-NO SHEATH CU;SnCuFe,52mm,GRY	1	SA	
W144	3811-001868	WIRE-NO SHEATH CU;SnCuFe,52mm,GRY	1	SA		W203	3811-001868	WIRE-NO SHEATH CU;SnCuFe,52mm,GRY	1	SA	
W145	3811-001868	WIRE-NO SHEATH CU;SnCuFe,52mm,GRY	1	SA		W204	3811-001868	WIRE-NO SHEATH CU;SnCuFe,52mm,GRY	1	SA	
W146	3811-001868	WIRE-NO SHEATH CU;SnCuFe,52mm,GRY	1	SA		W205	3811-001868	WIRE-NO SHEATH CU;SnCuFe,52mm,GRY	1	SA	
						W206	3811-001868	WIRE-NO SHEATH CU;SnCuFe,52mm,GRY	1	SA	

Loc. No.	Part No.	Description;Specification	Q'ty	SNA	Remark	Loc. No.	Part No.	Description;Specification	Q'ty	SNA	Remark
W207	3811-001868	WIRE-NO SHEATH CU;SnCuFe,52mm,GRY	1	SA		BR10	2001-000281	R-CARBON;100ohm,5%,1/8W,AA,TP,1.8x3	1	SA	
W208	3811-001868	WIRE-NO SHEATH CU;SnCuFe,52mm,GRY	1	SA		BR11	2001-000281	R-CARBON;100ohm,5%,1/8W,AA,TP,1.8x3	1	SA	
W209	3811-001868	WIRE-NO SHEATH CU;SnCuFe,52mm,GRY	1	SA		BR12	2001-000281	R-CARBON;100ohm,5%,1/8W,AA,TP,1.8x3	1	SA	
W210	3811-001868	WIRE-NO SHEATH CU;SnCuFe,52mm,GRY	1	SA		BR13	2001-000221	R-CARBON;1.2Kohm,5%,1/8W,AA,TP,1.8x	1	SA	
W211	3811-001868	WIRE-NO SHEATH CU;SnCuFe,52mm,GRY	1	SA		BR14	2001-000241	R-CARBON;1.5Kohm,5%,1/8W,AA,TP,1.8x	1	SA	
W212	3811-001868	WIRE-NO SHEATH CU;SnCuFe,52mm,GRY	1	SA		BR15	2001-000258	R-CARBON;1.8Kohm,5%,1/8W,AA,TP,1.8x	1	SA	
W213	0402-000127	DIODE-RECTIFIER;1N4002,100V,1A,DO-4	1	SA		BR16	2001-000449	R-CARBON;2.2Kohm,5%,1/8W,AA,TP,1.8x	1	SA	
W214	3811-001868	WIRE-NO SHEATH CU;SnCuFe,52mm,GRY	1	SA		BR17	2001-000837	R-CARBON;51Kohm,5%,1/8W,AA,TP,1.8x3	1	SA	
W215	3811-001868	WIRE-NO SHEATH CU;SnCuFe,52mm,GRY	1	SA		BR18	2001-000591	R-CARBON;3.3Kohm,5%,1/8W,AA,TP,1.8x	1	SA	
W216	3811-001868	WIRE-NO SHEATH CU;SnCuFe,52mm,GRY	1	SA		BR19	2001-000734	R-CARBON;4.7Kohm,5%,1/8W,AA,TP,1.8x	1	SA	
W217	3811-001868	WIRE-NO SHEATH CU;SnCuFe,52mm,GRY	1	SA		BR2	2001-000290	R-CARBON;10Kohm,5%,1/8W,AA,TP,1.8x3	1	SA	
W218	3811-001868	WIRE-NO SHEATH CU;SnCuFe,52mm,GRY	1	SA		BR3	2001-001153	R-CARBON(S);47ohm,5%,1/2W,AA,TP,2.4	1	SA	
W219	3811-001868	WIRE-NO SHEATH CU;SnCuFe,52mm,GRY	1	SA		BR4	2001-001153	R-CARBON(S);47ohm,5%,1/2W,AA,TP,2.4	1	SA	
W220	3811-001868	WIRE-NO SHEATH CU;SnCuFe,52mm,GRY	1	SA		BR5	2001-000995	R-CARBON;820ohm,5%,1/8W,AA,TP,1.8x3	1	SA	
W221	3811-001868	WIRE-NO SHEATH CU;SnCuFe,52mm,GRY	1	SA		BR6	2001-000281	R-CARBON;100ohm,5%,1/8W,AA,TP,1.8x3	1	SA	
W222	3811-001868	WIRE-NO SHEATH CU;SnCuFe,52mm,GRY	1	SA		BR7	2001-000281	R-CARBON;100ohm,5%,1/8W,AA,TP,1.8x3	1	SA	
W225	3811-001868	WIRE-NO SHEATH CU;SnCuFe,52mm,GRY	1	SA		BR8	2001-000281	R-CARBON;100ohm,5%,1/8W,AA,TP,1.8x3	1	SA	
W226	3811-001868	WIRE-NO SHEATH CU;SnCuFe,52mm,GRY	1	SA		BR9	2001-000429	R-CARBON;1Kohm,5%,1/8W,AA,TP,1.8x3	1	SA	
W227	3811-001868	WIRE-NO SHEATH CU;SnCuFe,52mm,GRY	1	SA		C20	2202-002055	C-CERAMIC,MLC-AXIAL;47nF,+80-20%,50	1	SA	
W228	3811-001868	WIRE-NO SHEATH CU;SnCuFe,52mm,GRY	1	SA		C21	2401-000487	C-AL;10uF,20%,50V,GP,TP,6.3x5mm,5	1	SA	
W229	3811-001868	WIRE-NO SHEATH CU;SnCuFe,52mm,GRY	1	SA		C26	2202-002055	C-CERAMIC,MLC-AXIAL;47nF,+80-20%,50	1	SA	
W230	3811-001868	WIRE-NO SHEATH CU;SnCuFe,52mm,GRY	1	SA		C27	2401-000487	C-AL;10uF,20%,50V,GP,TP,6.3x5mm,5	1	SA	
W231	3301-000297	BEAD-AXIAL;25ohm,3.6x1.2x5.7mm,-,TP	1	SA		FRONT PCB	AH41-01213A	PCB-FRONT;MM-DG25,KH,1,0,T1.6,168*1	0.5	SNA	
W232	3301-000297	BEAD-AXIAL;25ohm,3.6x1.2x5.7mm,-,TP	1	SA		IC1	1003-002129	IC-VFD;PT6315A,LQFP,44P,10x10mm,-40	1	SA	
W233	3811-001868	WIRE-NO SHEATH CU;SnCuFe,52mm,GRY	1	SA		LED1	0601-001739	LED;ROUND(Inverter);RED,3mm,660nm,	1	SA	
W234	3811-001868	WIRE-NO SHEATH CU;SnCuFe,52mm,GRY	1	SA		LED2	0601-001739	LED;ROUND(Inverter);RED,3mm,660nm,	1	SA	
W235	3811-001868	WIRE-NO SHEATH CU;SnCuFe,52mm,GRY	1	SA		LED3	0601-001739	LED;ROUND(Inverter);RED,3mm,660nm,	1	SA	
W236	3811-001868	WIRE-NO SHEATH CU;SnCuFe,52mm,GRY	1	SA		PZD1	0403-001321	DIODE-ZENER;MTZJ6.8C,6.7-6.97V,500m	1	SA	
W5	3811-001868	WIRE-NO SHEATH CU;SnCuFe,52mm,GRY	1	SA		REM-EYE	0609-001189	MODULE REMOCON;HORIZONTAL,16.4MM,TR	1	SA	
W6	3811-001868	WIRE-NO SHEATH CU;SnCuFe,52mm,GRY	1	SA		SW1	3404-000165	SWITCH-TACT;12V,50mA,160gf,6x6mm,SP	1	SA	
W7	3811-001868	WIRE-NO SHEATH CU;SnCuFe,52mm,GRY	1	SA		SW2	3404-000165	SWITCH-TACT;12V,50mA,160gf,6x6mm,SP	1	SA	
WR101	2007-000070	R-CHIP;0ohm,5%,1/10W,TP,1608	1	SA		SW3	3404-000165	SWITCH-TACT;12V,50mA,160gf,6x6mm,SP	1	SA	
WR102	2007-000070	R-CHIP;0ohm,5%,1/10W,TP,1608	1	SA		SW4	3404-000165	SWITCH-TACT;12V,50mA,160gf,6x6mm,SP	1	SA	
WR103	2007-000070	R-CHIP;0ohm,5%,1/10W,TP,1608	1	SA		SW5	3404-000165	SWITCH-TACT;12V,50mA,160gf,6x6mm,SP	1	SA	
WR104	2007-000070	R-CHIP;0ohm,5%,1/10W,TP,1608	1	SA		SW6	3404-000165	SWITCH-TACT;12V,50mA,160gf,6x6mm,SP	1	SA	
WR105	2007-000070	R-CHIP;0ohm,5%,1/10W,TP,1608	1	SA		SW7	3404-000165	SWITCH-TACT;12V,50mA,160gf,6x6mm,SP	1	SA	
WR106	2007-000070	R-CHIP;0ohm,5%,1/10W,TP,1608	1	SA		SW8	3404-000165	SWITCH-TACT;12V,50mA,160gf,6x6mm,SP	1	SA	
WR107	2007-000070	R-CHIP;0ohm,5%,1/10W,TP,1608	1	SA		SW9	3404-000165	SWITCH-TACT;12V,50mA,160gf,6x6mm,SP	1	SA	
WR108	2007-000070	R-CHIP;0ohm,5%,1/10W,TP,1608	1	SA		UC24	2401-000487	C-AL;10uF,20%,50V,GP,TP,6.3x5mm,5	1	SA	
WR109	2007-000070	R-CHIP;0ohm,5%,1/10W,TP,1608	1	SA		VFD FILTER	AH63-01861A	SHEET-VFD;MM-DG25,PC,0.5,33,80	1	SNA	
X-TAL1	2802-001174	RESONATOR-CERAMIC;10MHZ,0.5%,BK,8X3	1	SA		VFD1	AH07-00249A	VF DISPLAY;HNV-10MS31T,MAX-DG55,80.	1	SA	
X-TAL1A	2801-001394	CRYSTAL-UNIT;32.768KHz,20ppm,28-AA	1	SA		VFD-HOLDER	AH61-02727A	HOLDER-VFD;HIPS,MAX-G55,41,82	1	SA	
ZD1S30	0403-000537	DIODE-ZENER;1N4749A,5%,1000mW,DO-41	1	SA		W102	3811-001868	WIRE-NO SHEATH CU;SnCuFe,52mm,GRY	1	SA	
	AH99-00300A	ASSY AUTO INSERT;MAIN PCB ASSY,MM-	1	SNA		W103	3811-001868	WIRE-NO SHEATH CU;SnCuFe,52mm,GRY	1	SA	
PCB-FRONT	AH92-03027A	ASSY PCB FRONT;MINI-DVD/CD,MM-DG25,	1	SA		W105	3811-001868	WIRE-NO SHEATH CU;SnCuFe,52mm,GRY	1	SA	
BC1	2202-002055	C-CERAMIC,MLC-AXIAL;47nF,+80-20%,50	1	SA		W106	3811-001868	WIRE-NO SHEATH CU;SnCuFe,52mm,GRY	1	SA	
BC2	2202-000797	C-CERAMIC,MLC-AXIAL;10NF,30%,16V,Y5	1	SA		W107	3811-001868	WIRE-NO SHEATH CU;SnCuFe,52mm,GRY	1	SA	
BC3	2202-002055	C-CERAMIC,MLC-AXIAL;47nF,+80-20%,50	1	SA		W108	3811-001868	WIRE-NO SHEATH CU;SnCuFe,52mm,GRY	1	SA	
BC5	2202-002037	C-CERAMIC,MLC-AXIAL;100nF,+80-20%,5	1	SA		AH99-00281A	ASSY AUTO INSERT;FRONT ASSY PCB,MM	1	SNA		
BC6	2202-002055	C-CERAMIC,MLC-AXIAL;47nF,+80-20%,50	1	SA		AH97-00846A	ASSY SUB MATERIAL;AH97-00846A,-,-,-	1	SNA		
BCW1	3708-000411	CONNECTOR-FPC/FPC/PIC;12P,1.25mm,ST	1	SA		0201-001356	CEMEDINE;A121	0.003	SNA		
BCW2	AH39-20008M	LEAD CONNECTOR ASSY;5264,5395,2P,15	1	SA		0201-001357	ADHESIVE-STRL;THREE BOND 1401B,GRN,	0.5	SNA		
BCW3	3711-000814	HEADER-BOARD TO CABLE;BOX,2P,1R,2.5	1	SA		FIL	0203-000007	TAPE-FILAMENT;T0.15,L55M,TRP	0.1	SNA	
BD1	0401-000005	DIODE-SWITCHING;1N4148,75V,150mA,DO	1	SA			0203-001100	TAPE-OPP MASKING;OPP/W75/CLR,T0.05,	1.5	SNA	
BD3	0401-000005	DIODE-SWITCHING;1N4148,75V,150mA,DO	1	SA			0203-001362	TAPE-DOUBLE FACE;#570 W10X50M CLR	0.1	SNA	
BD5	0401-000005	DIODE-SWITCHING;1N4148,75V,150mA,DO	1	SA			0205-001366	GREASE-SILICON;T4110	1.4	SNA	
BR1	2001-000290	R-CARBON;10Kohm,5%,1/8W,AA,TP,1.8x3	1	SA							

Exploded View & Part List

Loc. No.	Part No.	Description;Specification	Q'ty	SNA	Remark	Loc. No.	Part No.	Description;Specification	Q'ty	SNA	Remark
	AH98-00218P	ASSY ACCESSORY-KITTING;-;MM-G25T/XA	1	SNA							
	6801-001558	CARD-WARRANTY;PANAMA,XAP,ENG,MOJO10	1	SNA							
	6902-000385	BAG PE;LDPE,T0.03,W250,L350,TRP,8,1	1	SA							
	AH39-00320C	CBF COAXIAL CABLE;MAX-L68,110REC,10	1	SA							
	AH68-02157L	MANUAL USERS;MM-G25,XAX,SPA,MOJO80G	1	SA							
	AH68-02157Z	MANUAL USERS;MM-G25,XAP,ENG,MOJO80G	1	SA							
	AH68-50254B	LABEL-SERIAL;T0.1,L10,W45,SME/SEHZ	1.05	SNA							
	AH98-00219P	ASSY LABEL;-;MM-G25T/XAP;-;	1	SNA							
	3809-001434	CABLE-FLAT;30V,80C,100MM,12P,1.25MM	1	SA							
	3809-002301	CABLE-FLAT;30V,80C,100mm,27P,1.25mm	1	SA							
	AH63-01301A	SHEET-SET;HT-Q40	1	SNA							
	AH68-00371A	LABEL-BAR CODE;DVD-611/XAA,MOJO2000	1.05	SNA							
	AH68-01929G	LABEL RATING;HT-A100,XTL,SLIVER PET	1.05	SNA							
	AH68-02189E	LABEL-POP;MM-G25,NOEUR,RAINBOW,0.18	1	SNA							
	AH69-02459A	CUSHION-R;MM-DG25,EPS,98,191.7,385,	1	SNA							
	AH69-02460A	CUSHION-L;MM-DG25,EPS,46,191.7,385,	1	SNA							
	AC39-10200N	CBF-POWER CORD;AT,US,EP2/Y,HOUSING(1	SA							
	AH69-02602C	CARTON-MARSTER;MM-DG25,PAPER,7,332,	1.02	SA							
	AH96-00010A	ASSY DECK;MAX-DG89,WITH DOOR,CABLE	1	SA							

3. Disassembly & Reassembly





3-1 Overall Disassembly & Reassembly



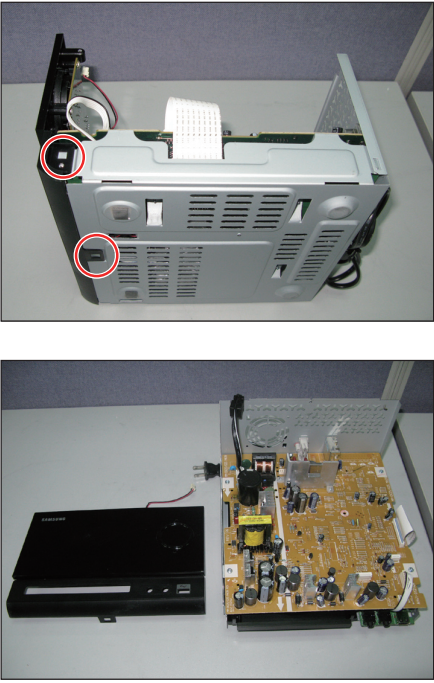
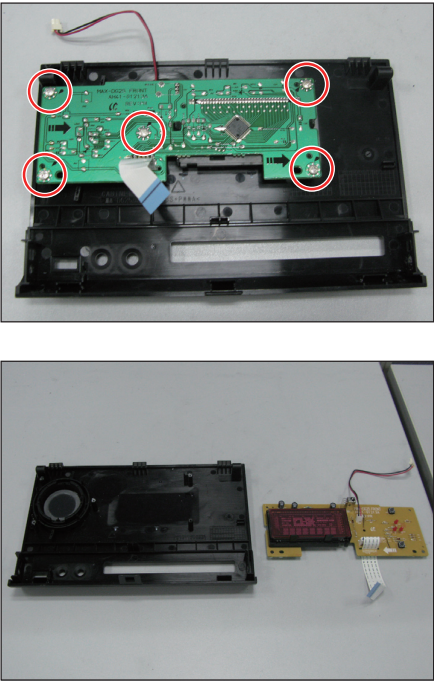

- Be careful to follow the disassembly sequence described in the manual. Otherwise, the product may be damaged.
- Be sure to carefully read and understand the safety instructions before performing any work as the IC chips on the PCB are vulnerable to static electricity.
- Assemble in the reverse order of disassembly.

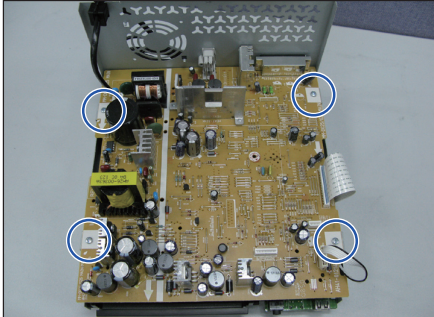
No.	Part Name	Description	Description Photo
1	CABINET-TOP	<p>1) Unfasten 6 screws on the CABINET-TOP side and the one in the middle. : BH,3*10,BLACK</p> <div style="border: 1px solid black; padding: 5px; margin-top: 10px;"> <p>⚠ Be careful not to make any scratches as you remove it.</p> </div>	

No.	Part Name	Description	Description Photo
2	CABINET-FRONT	1) Turn over the hook of CABINET-BOTTOM and separate ASSY-FRONT.	
3	FRONT-PCB	1) Unfasten 5 screws. : BH,3*8,WHITE	

No.	Part Name	Description	Description Photo
4	MAIN-PCB	1) Unfasten 2 screws on the the CABINET-BOTTOM and 4 screws on the MAIN-PCB. : BH,3*10,BLACK - 2EA (○) : BH,3*8,WHITE - 4EA (○)	 <p data-bbox="987 611 1349 642"><MM-DG25 CABINET-BOTTOM></p>  <p data-bbox="995 1016 1341 1047"><MM-G25 CABINET-BOTTOM></p>  

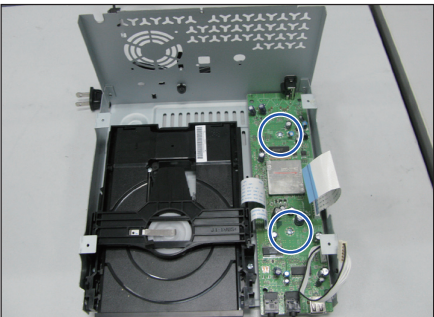
No.	Part Name	Description	Description Photo
5	MPEG-PCB	<p>1) Unfasten the MM-DG25 - 2 screws or MM-G25 - 1 screw on the CABINET-BOTTOM and 2 screws on the MPEG-PCB.</p> <p>: BH,3*10,BLACK - 2EA (○)</p> <p>: BH,3*8,WHITE - 2EA (○)</p>	 <p><MM-DG25 CABINET-BOTTOM></p>  <p><MM-G25 CABINET-BOTTOM></p> 

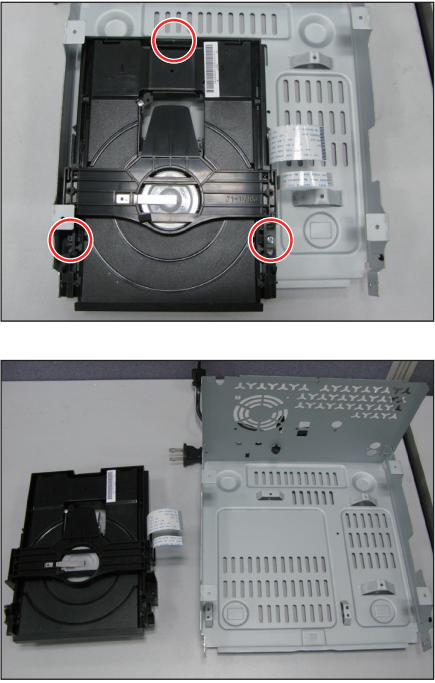
No.	Part Name	Description	Description Photo
6	CD-DECK	1) Unfasten 3 screws on the CD-DECK. : BH,3*10,BLACK	

MEMO

7. Schematic Diagram

7-1 Overall Block Diagram.....	7-2
7-2 FRONT.....	7-3
7-3 TAPE.....	7-4
7-4 MAIN.....	7-5
7-5 MPEG.....	7-6
7-6 SMPS.....	7-7

7-1 Overall Block Diagram

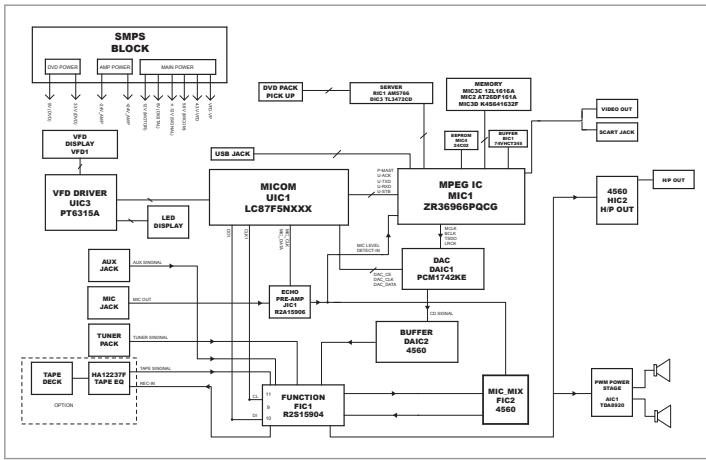

■ Main System MICOM control Function IC (R2S15904), Turner pack, Tape deck IC (DIC1HA12237F), CD/DVD deck. It gets all information from R2S15904. They have a communication among with HOST ↔ SLAVE interface. And Main System MICOM gets the information from User's remote control. So whenever it gets the information, it displays it on the VFD.

■ The DVD/CD Deck and Tape Deck transfer the audio data to R2S15904.

■ AUX Jack and Tuner pack are each connected to R2S15904. Data from AUX and tuner transfer to R2S15904. Then, after processing, the data will send the data to AMP IC.

7-3 TAPE

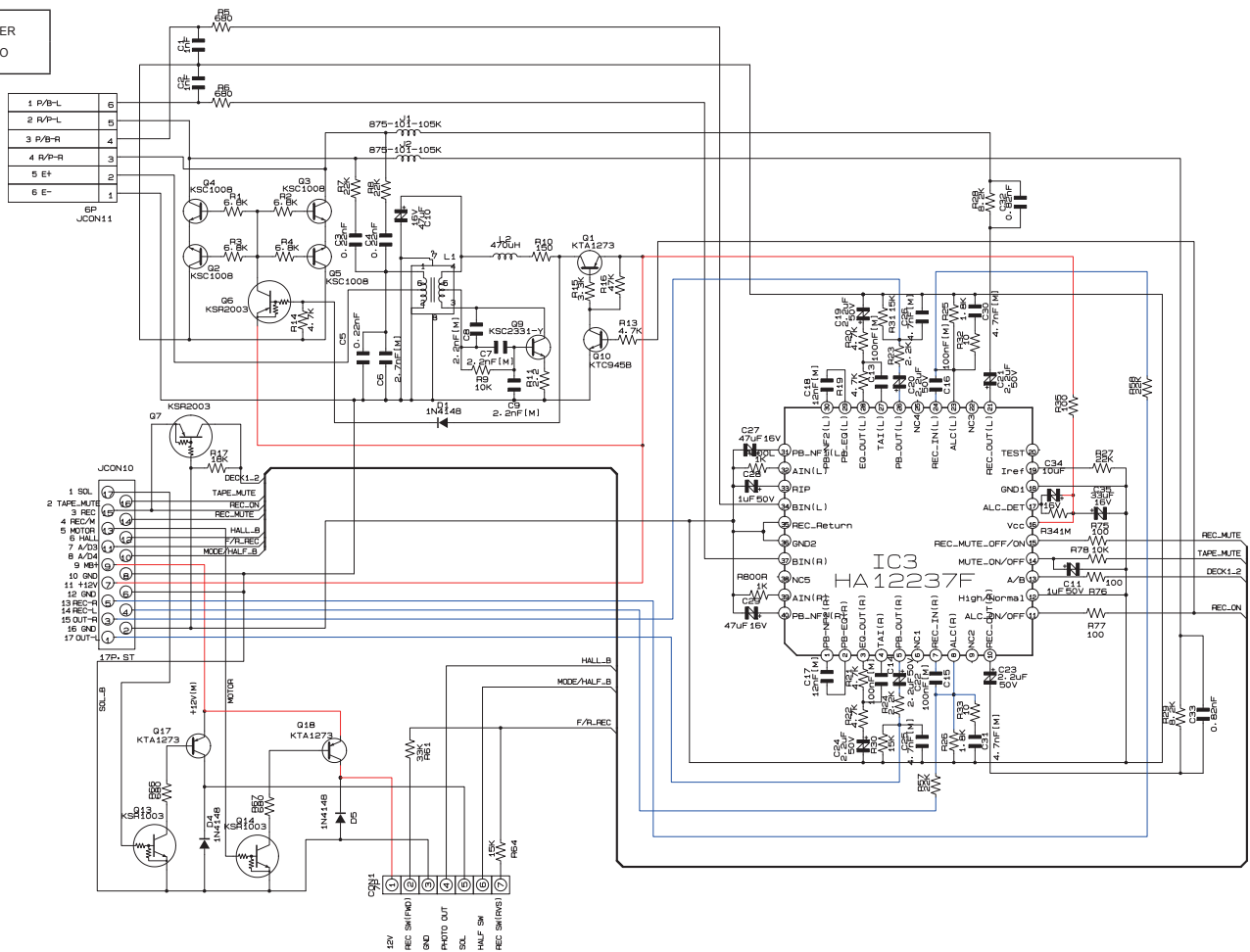
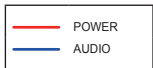

7-4 MAIN

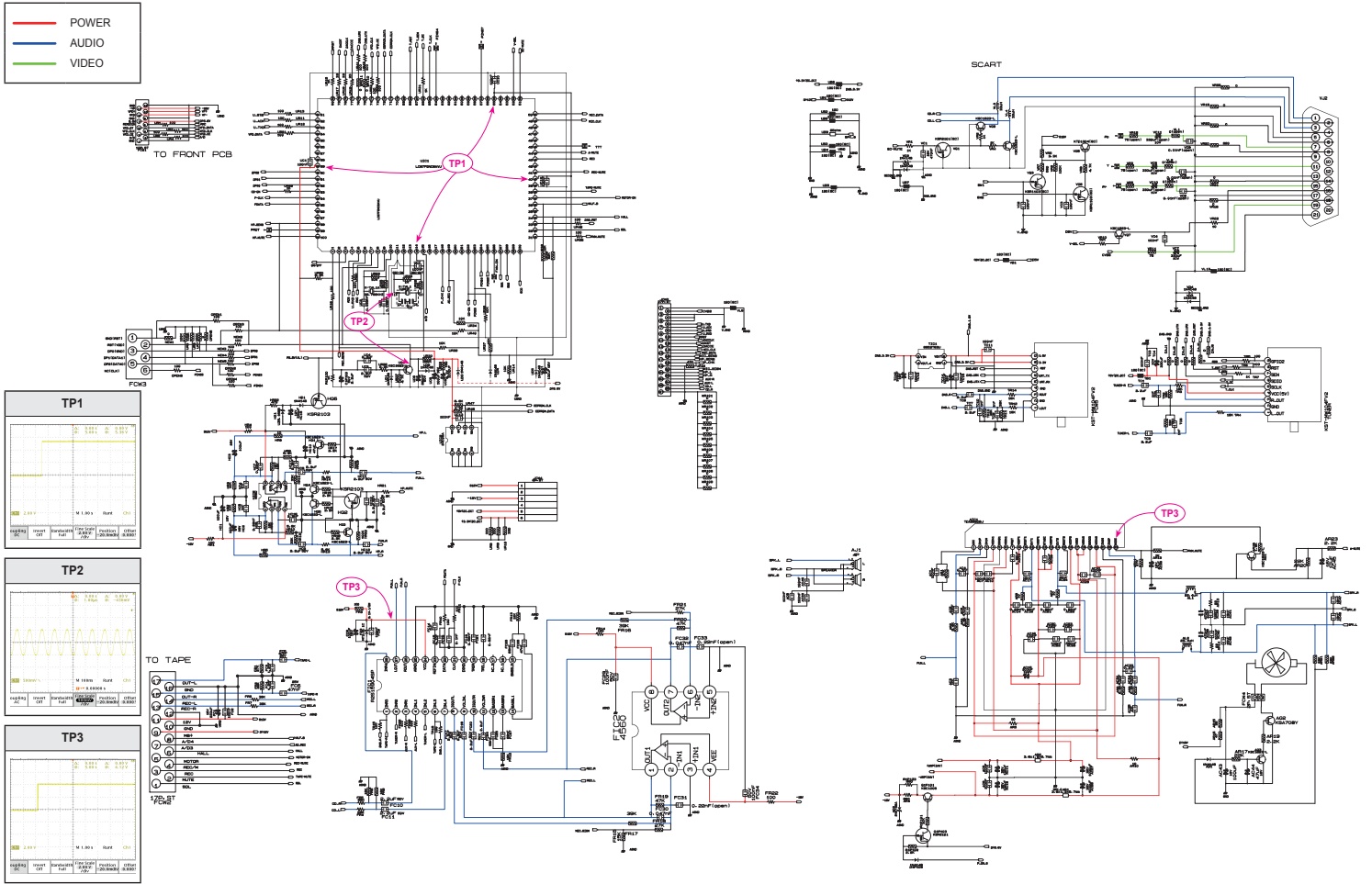

7-5 MPEG

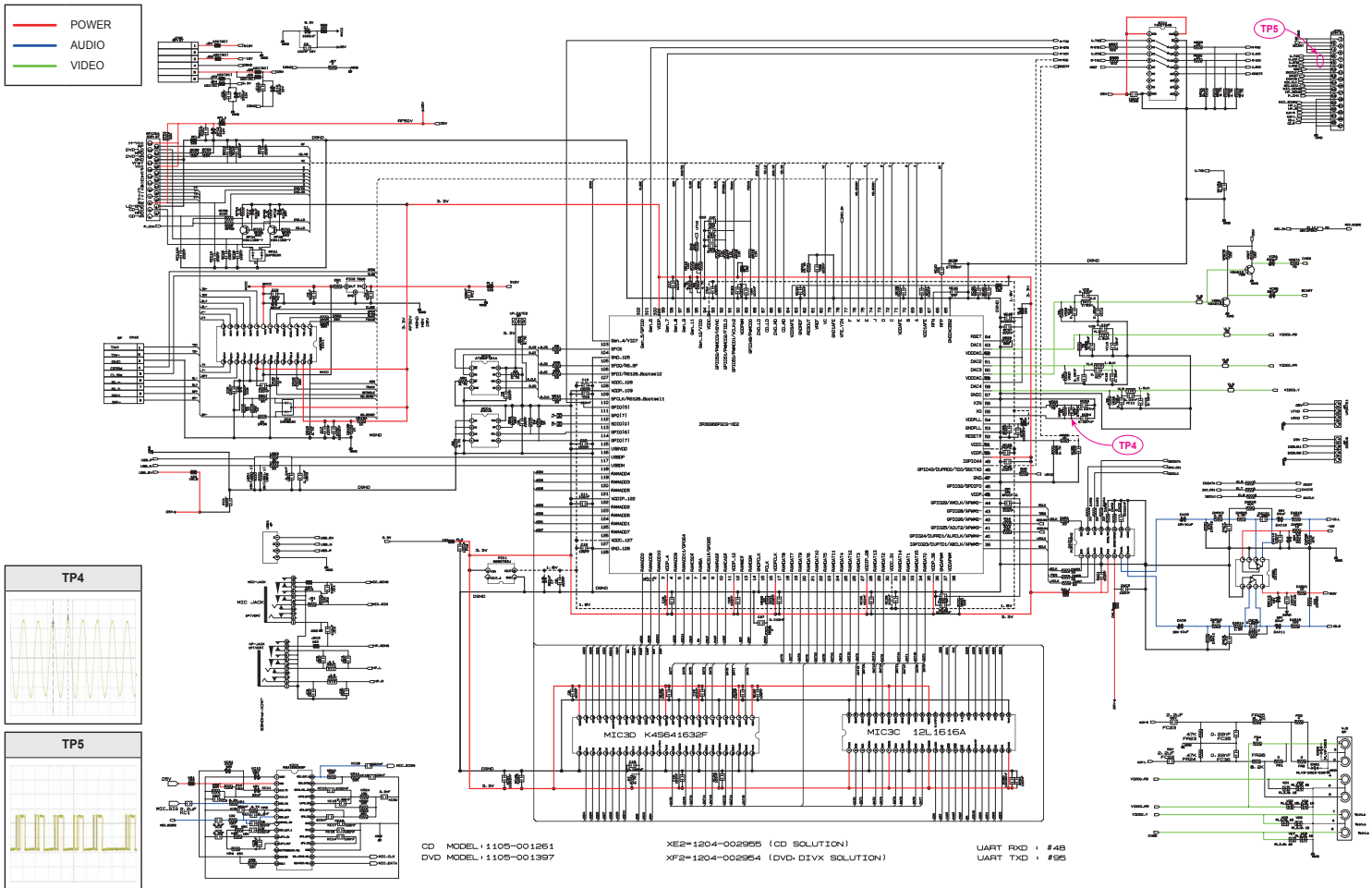

7-6 SMPS

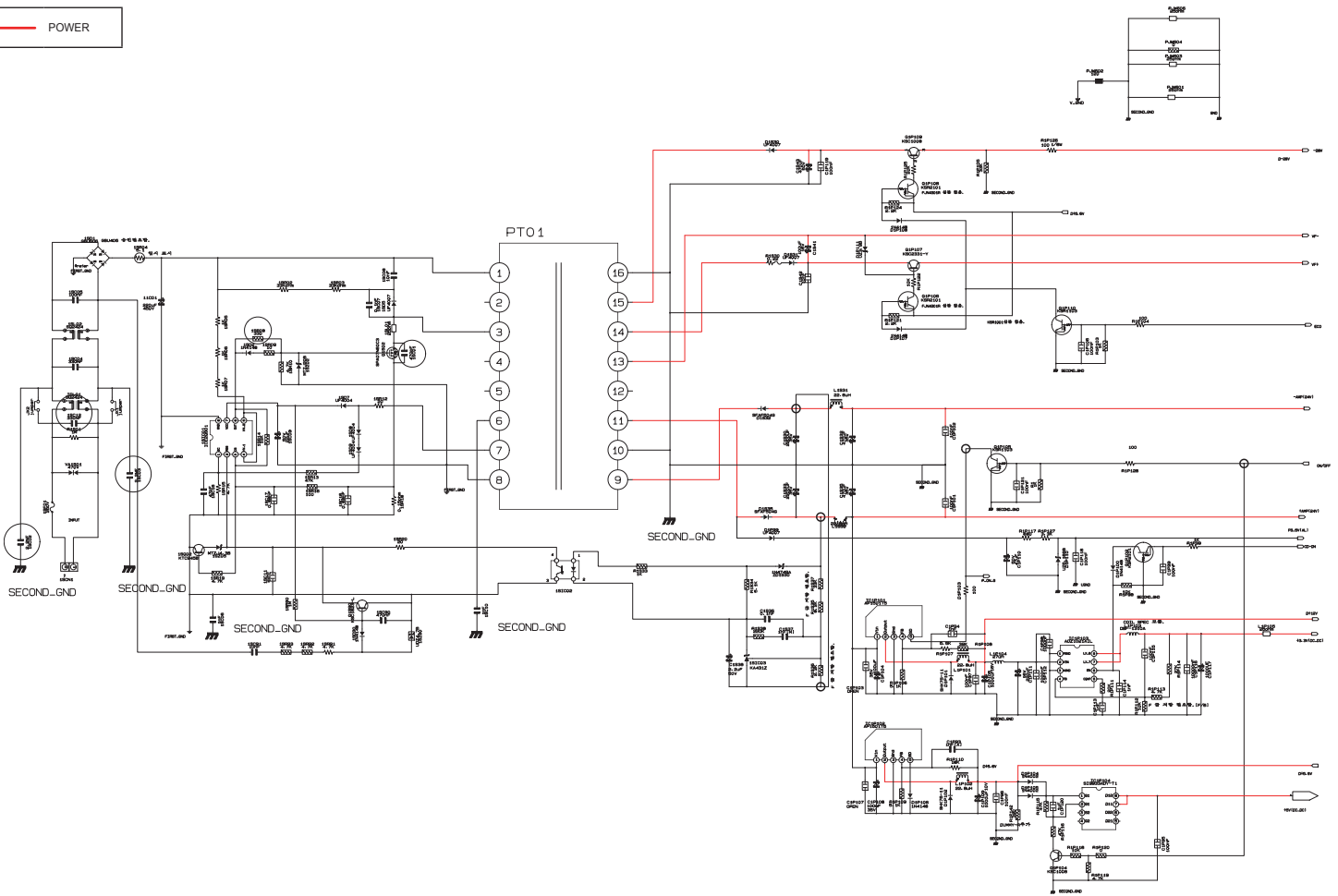

MEMO

6. PCB Diagram

6-1	Wiring Diagram.....	6-2
6-2	FRONT PCB Top.....	6-3
6-3	FRONT PCB Bottom	6-5
6-4	TAPE PCB Top.....	6-6
6-5	TAPE PCB Bottom.....	6-8
6-6	MAIN PCB Top.....	6-9
6-7	MAIN PCB Bottom.....	6-12
6-8	MPEG PCB Top.....	6-14
6-9	MPEG PCB Bottom	6-17

6-1 Wiring Diagram

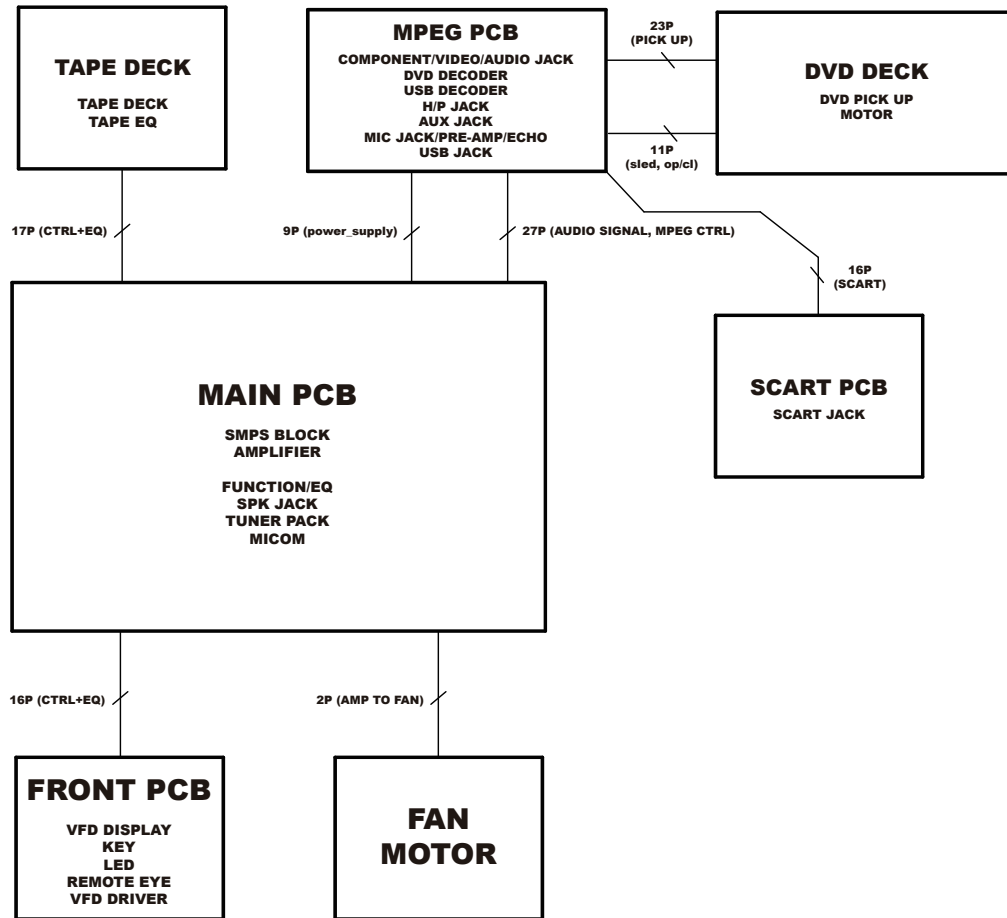

6-2 FRONT PCB Top

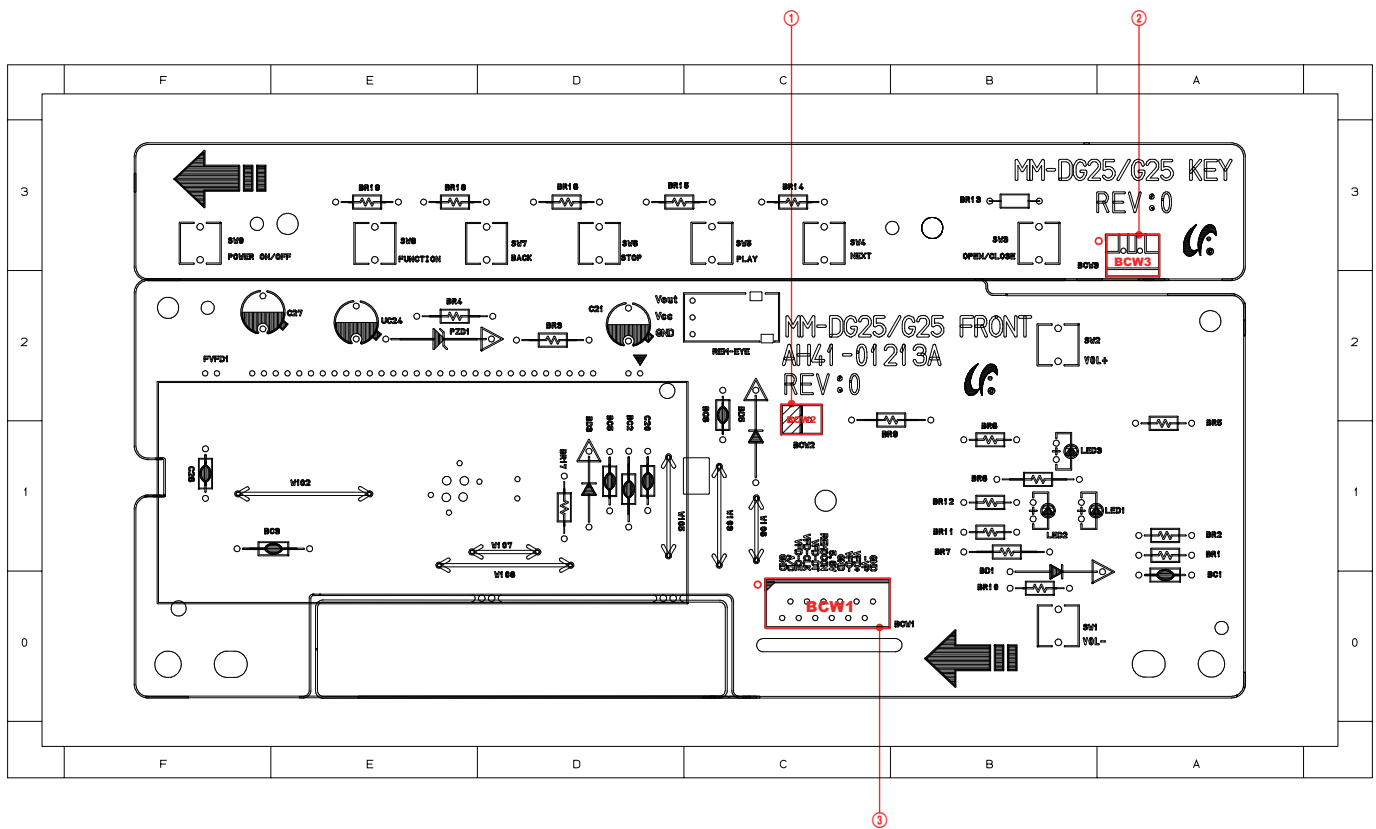

6-2-1 Pin Connection

① BCW2
KEY PCB Control Connector

Pin No.	Signal
1	GND
2	A/D

② BCW3
KEY PCB Control Connector

Pin No.	Signal
1	GND
2	A/D

③ BCW1
FRONT PCB Control Connector

Pin No.	Signal
1	GND
2	A/D
3	VFD_CE
4	VFD_CLK
5	VFD_DT
6	REMOCON
7	5.6V
8	GND
9	VFD-
10	VFD+
11	-VP
12	GND

6-3 FRONT PCB Bottom

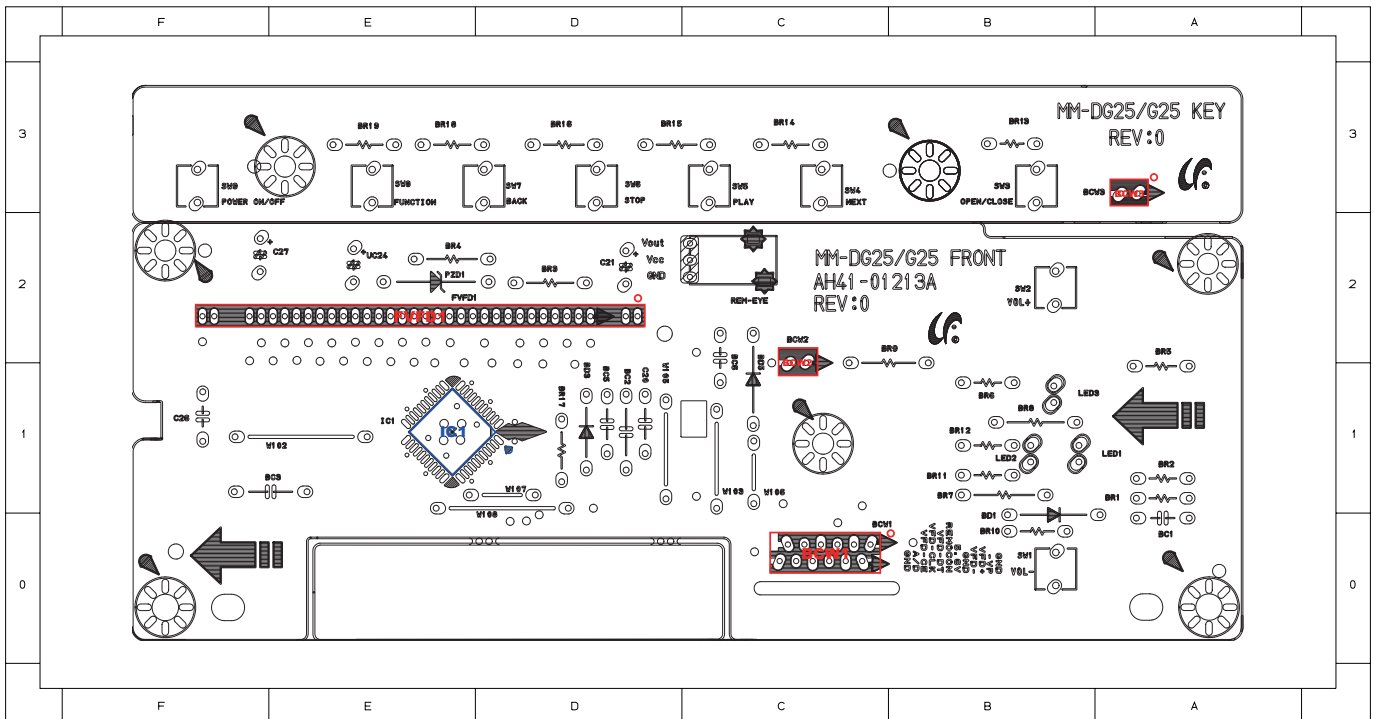

6-4 TAPE PCB Top

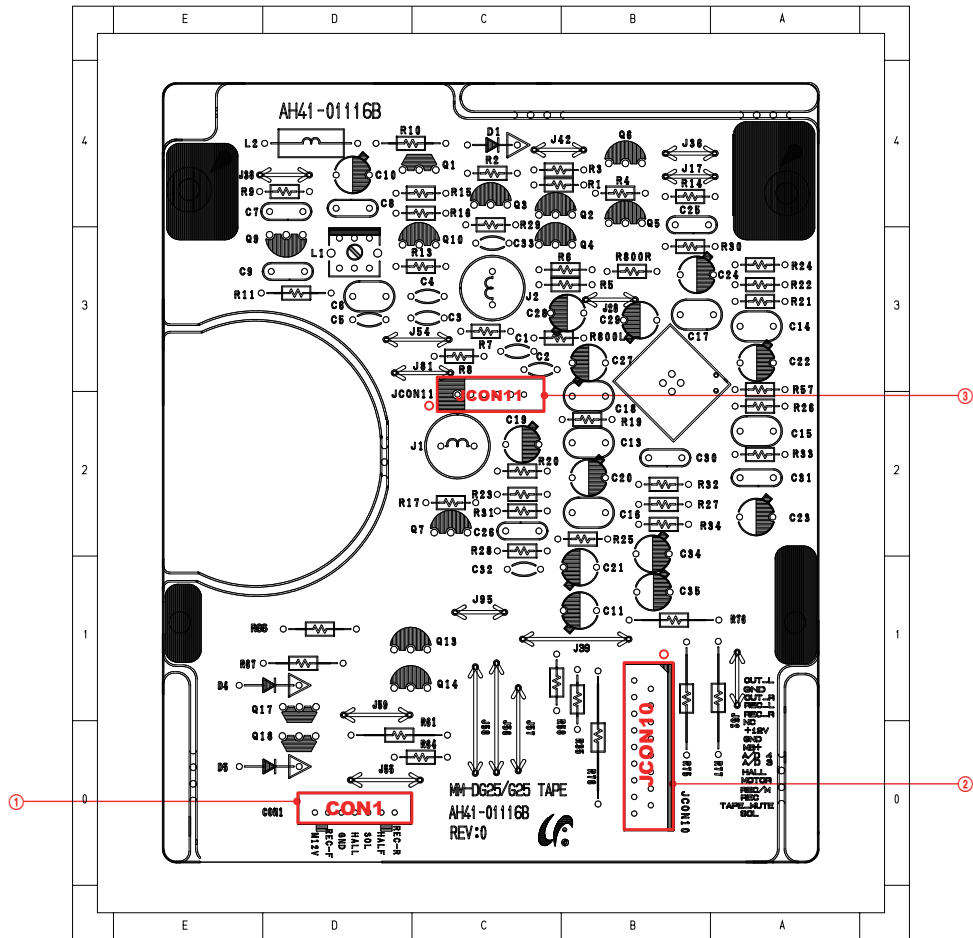

6-4-1 Pin Connection① CON1
TAPE DECK Status

Pin No.	Signal
1	12V
2	REC SW(FWD)
3	GND
4	PHOTO OUT
5	SOL
6	HALF SW
7	REC SW(RVS)

② JCON10
TAPE DECK Control/Signal Connector

Pin No.	Signal
1	SOL
2	TAPE_MUTE
3	REC
4	REC/M
5	MOTOR
6	HALL
7	A/D3
8	A/D4
9	MB+
10	GND
11	+12V
12	GND
13	REC-R
14	REC-L
15	OUT-R
16	GND
17	OUT-L

③ JCON11
TAPE DECK Motor Control

Pin No.	Signal
1	P/B-L
2	R/P-L
3	P/B-R
4	R/P-R
5	E+
6	E-

6-6 MAIN PCB Top

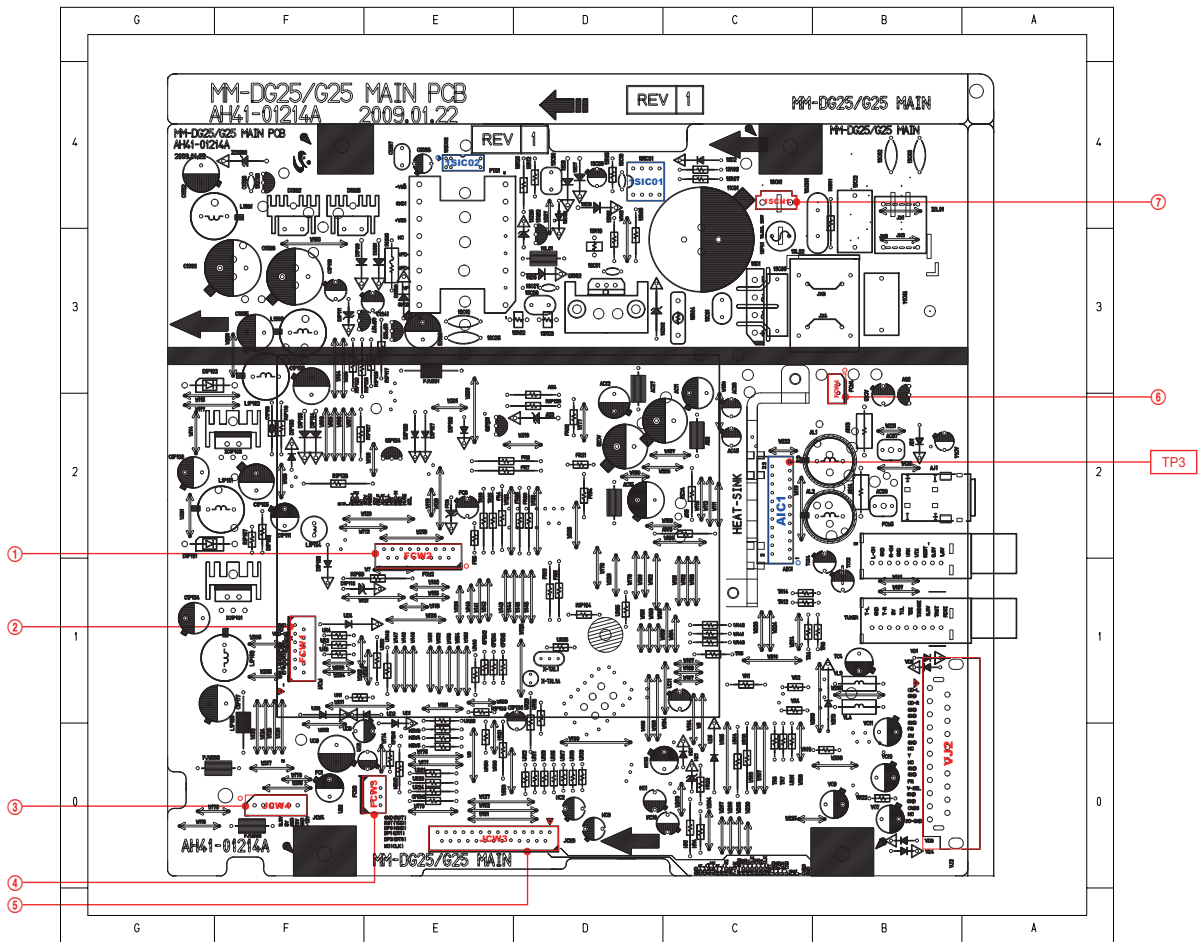

6-6-1 Pin Connection

① FCW2
TAPE DECK Control/Signal Connector

Pin No.	Signal
1	SOL
2	TAPE_MUTE
3	REC
4	REC/M
5	MOTOR
6	HALL
7	A/D3
8	A/D4
9	MB+
10	GND
11	+12V
12	GND
13	REC-R
14	REC-L
15	OUT-R
16	GND
17	OUT-L

② FCW1
FRONT PCB Control Connector

Pin No.	Signal
1	GND
2	A/D
3	VFD_CE
4	VFD_CLK
5	VFD_DT
6	REMOCON
7	5.6V
8	GND
9	VFD-
10	VFD+
11	-VP
12	GND

③ JCW4
MPEG Power

Pin No.	Signal
1	S12V
2	AGND
3	-12V
4	GND
5	+5V
6	+3.3V

④ FCW3
MICOM Update

Pin No.	Signal
1	GND
2	RST
3	DP0
4	DP1
5	DP2
6	NC

⑤ JCW3
MPEG PCB Connector (Data)

Pin No.	Signal
1	AGND
2	CVBS
3	VGND
4	VGND
5	VGND
6	U_TXD
7	U_ACK
8	U_STB
9	U_RXD
10	MRST
11	DACCLK
12	DACDT
13	DACCE
14	MIC_CLK
15	MIC_DATA
16	MIC_SENS
17	HP_SENS
18	P_CHK
19	AGND
20	MIC_SIGN
21	HP_L
22	HP_R
23	AUX-R
24	AUX-L
25	CD_L
26	CD_R
27	AGND

⑥ FCW4
FAN Control

Pin No.	Signal
1	+12V
2	GND

⑦ 1SCN1
POWER CORD

Pin No.	Signal
1	AC_IN
2	AC_IN

6-6-2 Test Point Wave Form

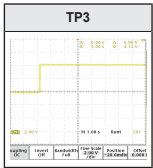

6-7 MAIN PCB Bottom

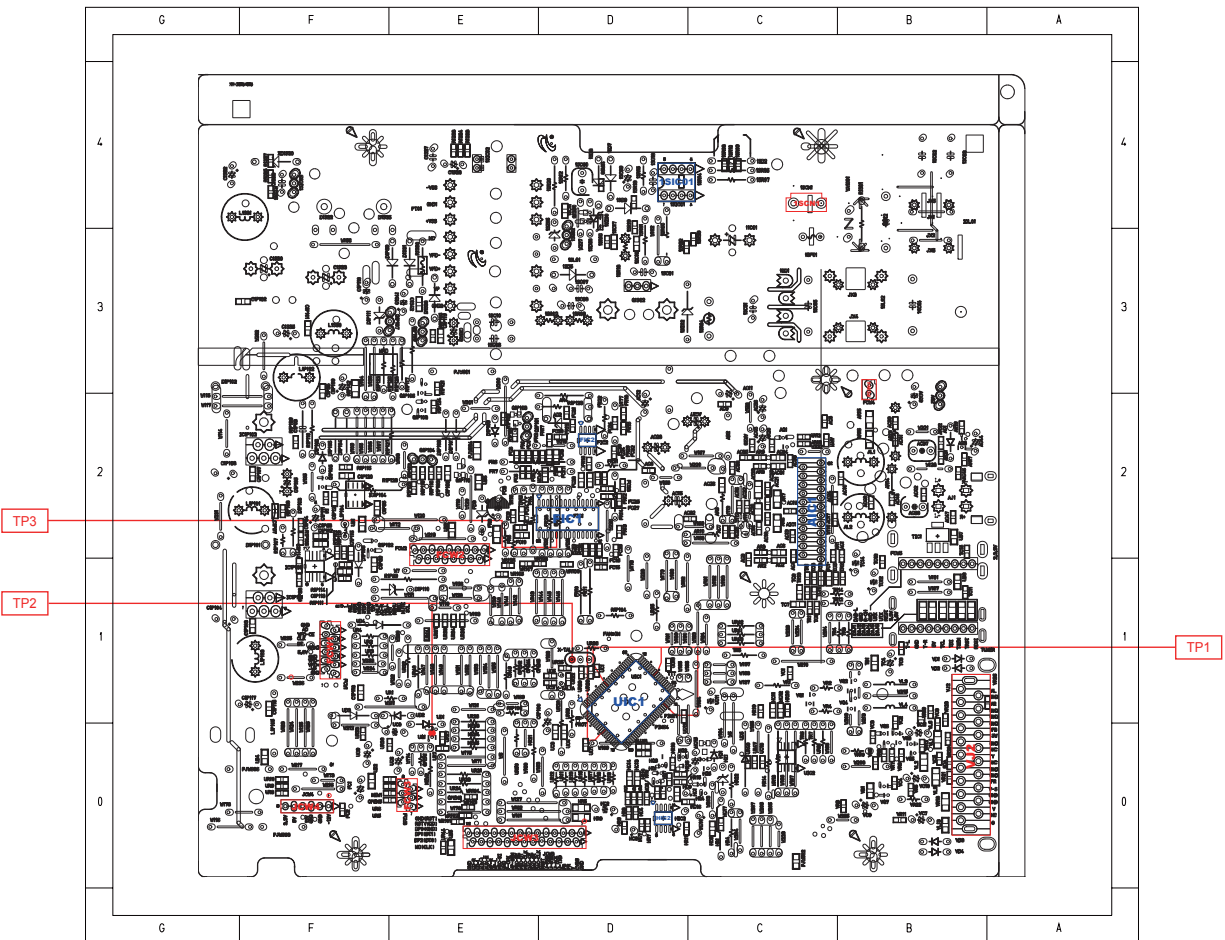

6-7-1 Test Point Wave Form

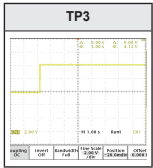
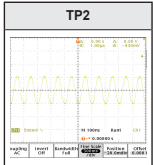
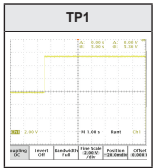

6-8 MPEG PCB Top

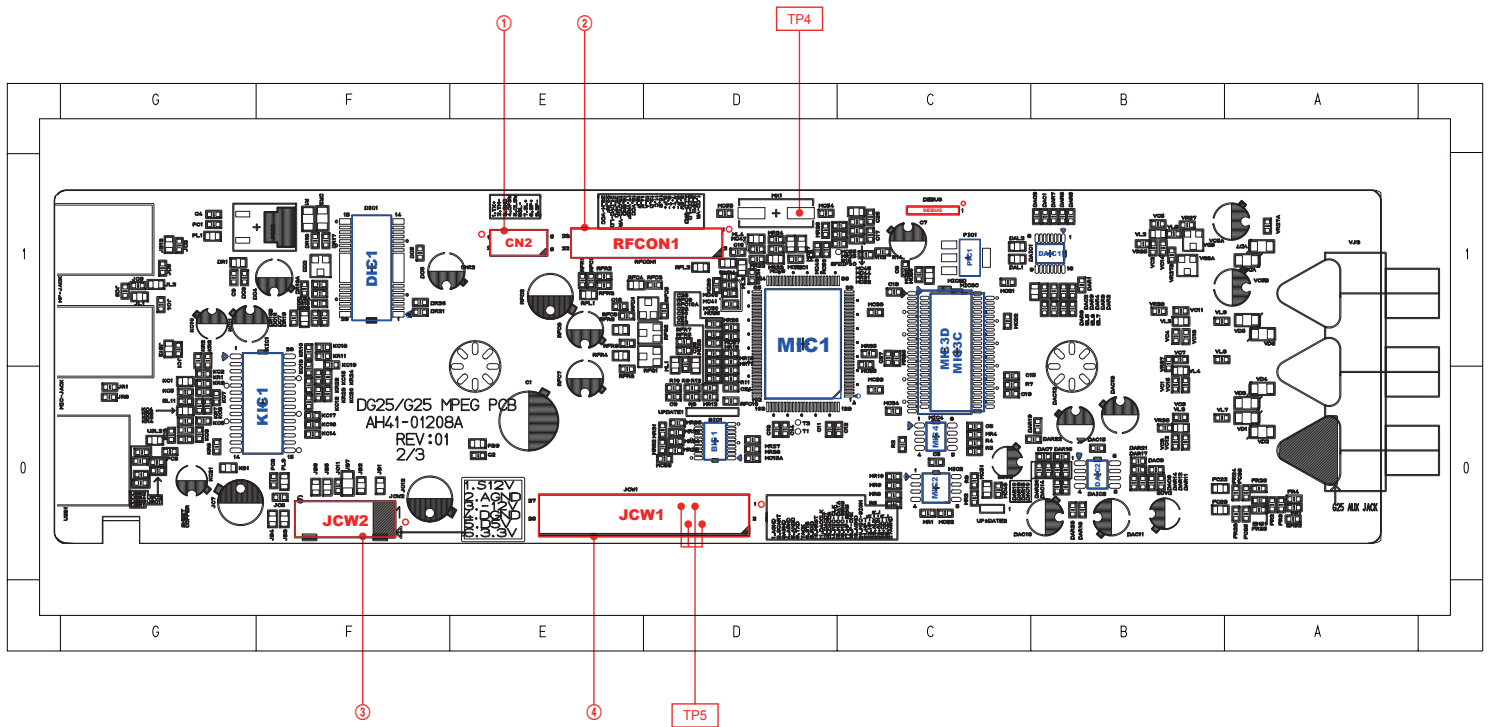

6-8-1 Pin Connection

① CN12
Motor Control

Pin No.	Signal
1	TM+
2	TM-
3	ND
4	OPSW
5	CLSW
6	SL-
7	SL+
8	SP+
9	SP-

② RFCON1
DECK Data

Pin No.	Signal
1	CD-VR
2	MPD
3	CD-LD
4	LD-GND
5	SW
6	F-
7	T+
8	T-
9	F+
10	B
11	C
12	D
13	A
14	E
15	F
16	Vcc
17	Vref
18	GND
19	DVD-VR
20	PD
21	DVD-LD
22	RFCON1
23	H-Vcc

③ JCW2
MPEG Power

Pin No.	Signal
1	S12V
2	AGND
3	-12V
4	GND
5	+5V
6	+3.3V

④ JCW1
MPEG PCB Connector (Data)

Pin No.	Signal
1	AGND
2	CVBS
3	VGND
4	VGND
5	VGND
6	U_TXD
7	U_ACK
8	U_STB
9	U_RXD
10	MRST
11	DACCLK
12	DACDT
13	DACCE
14	MIC_CLK
15	MIC_DATA
16	MIC_SENS
17	HP_SENS
18	P_CHK
19	AGND
20	MIC_SIGN
21	HP_L
22	HP_R
23	AUX-R
24	AUX-L
25	CD_L
26	CD_R
27	AGND

PCB Diagram

6-8-2 Test Point Wave Form

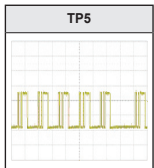
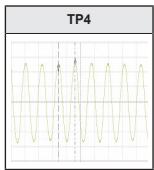

6-9 MPEG PCB Bottom

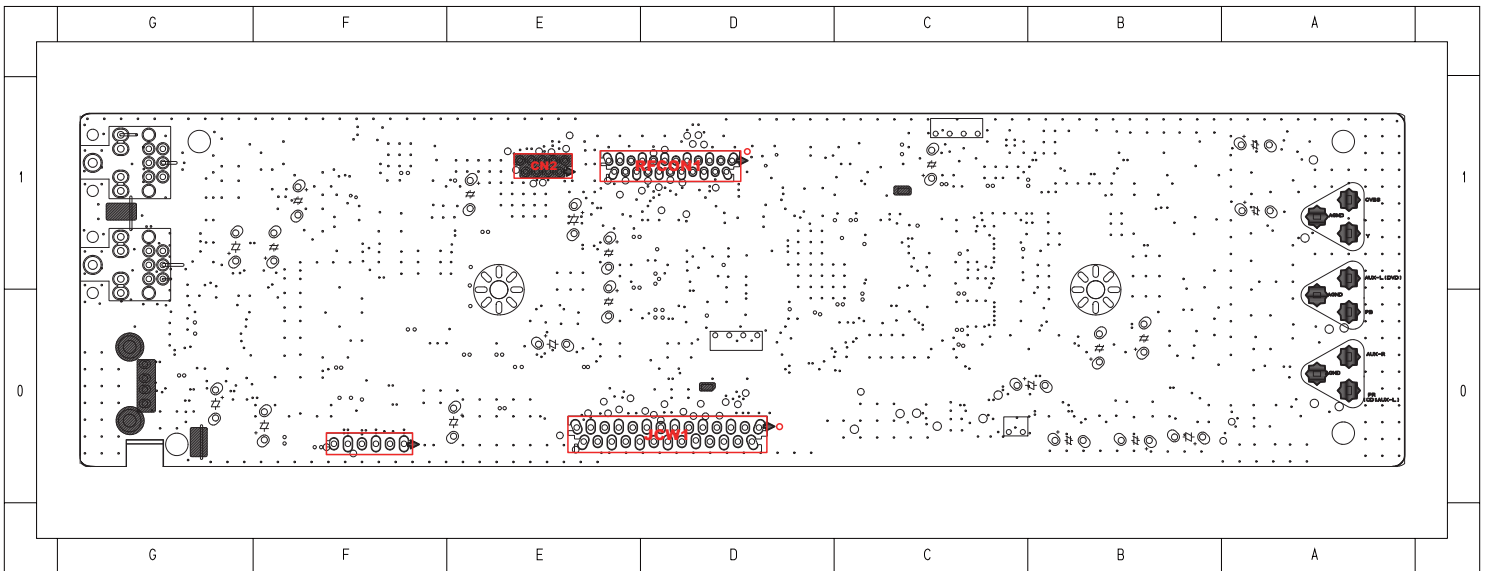

MEMO

4. Troubleshooting

4-1	Checkpoints by Error Mode	4-2
4-2	MICOM, MPEG Initialization & Update.....	4-11
4-3	Buyer-Region Code Setting Method.....	4-12

4-1 Checkpoints by Error Mode

4-1-1 No Power

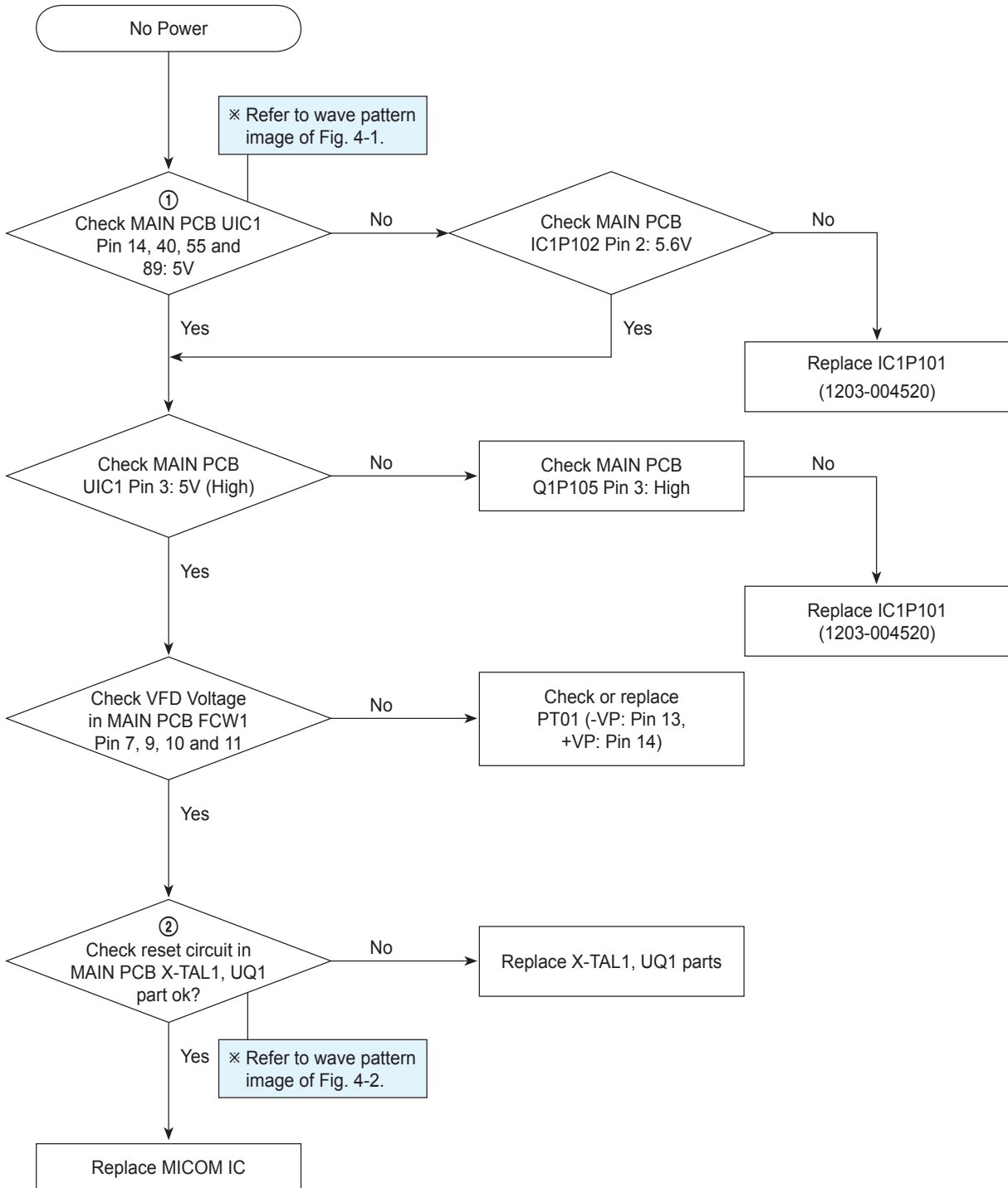

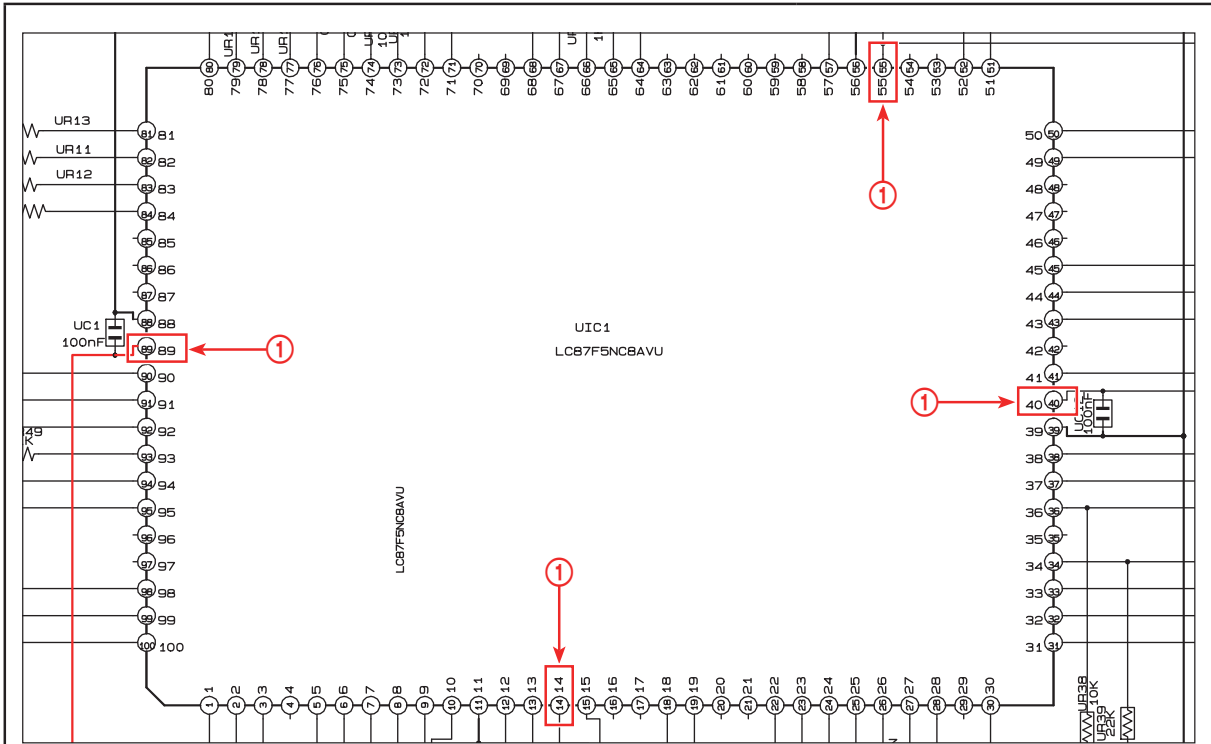

※ MAIN, page 7-5

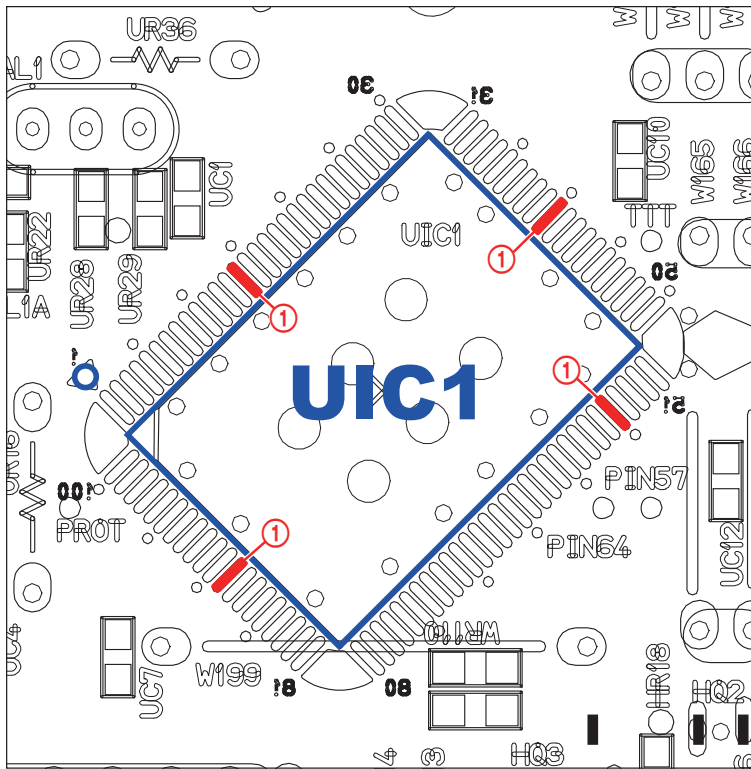

※ MAIN PCB Bottom, page 6-12

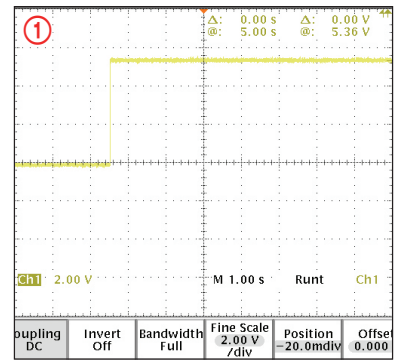

<Fig. 4-1>

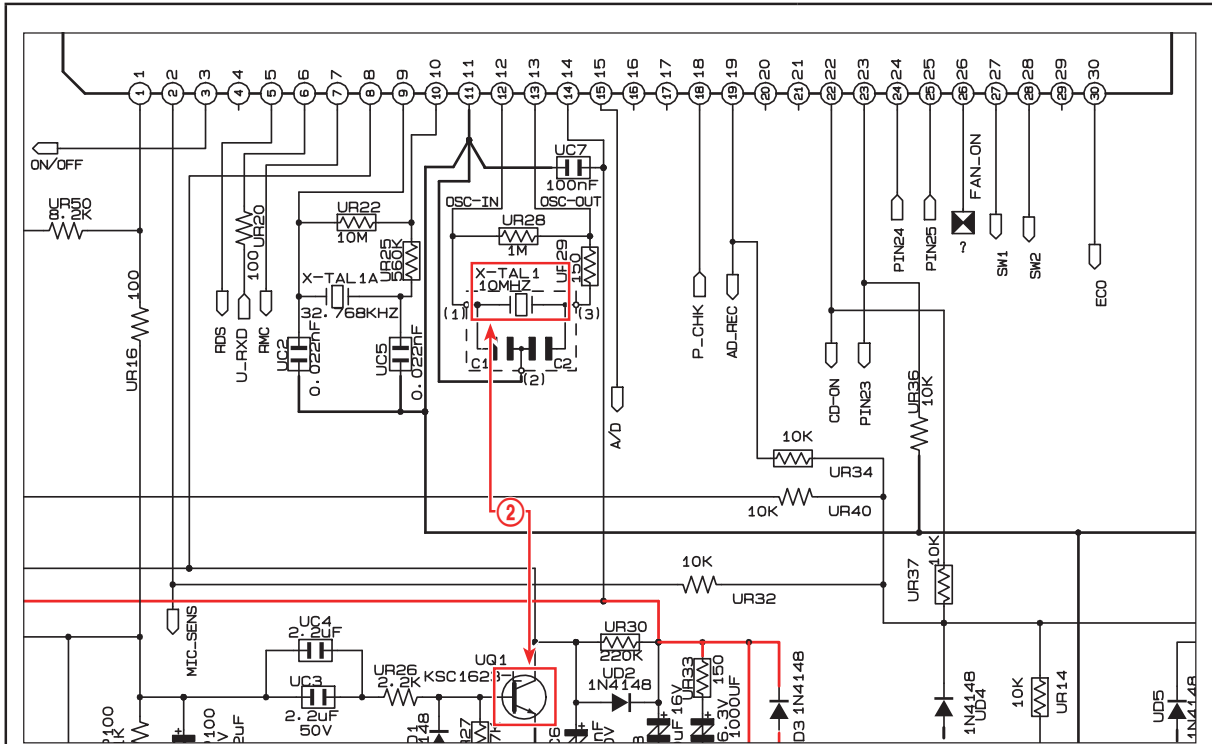

※ MAIN, page 7-5



※ MAIN PCB Bottom, page 6-12

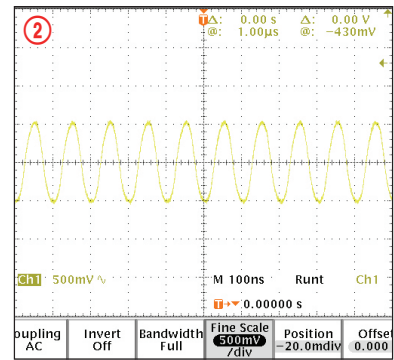

<Fig. 4-2>

4-1-2 No Output

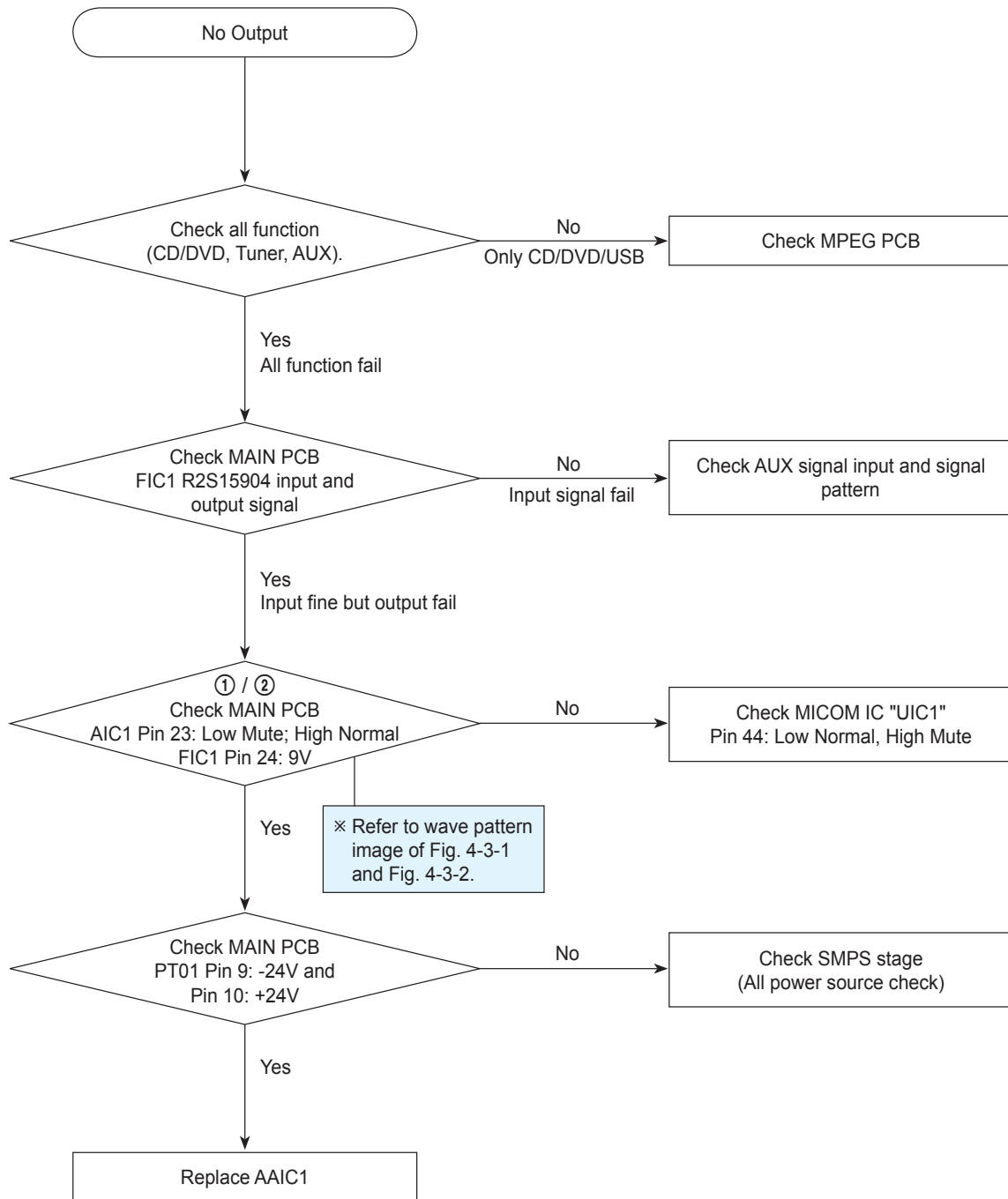

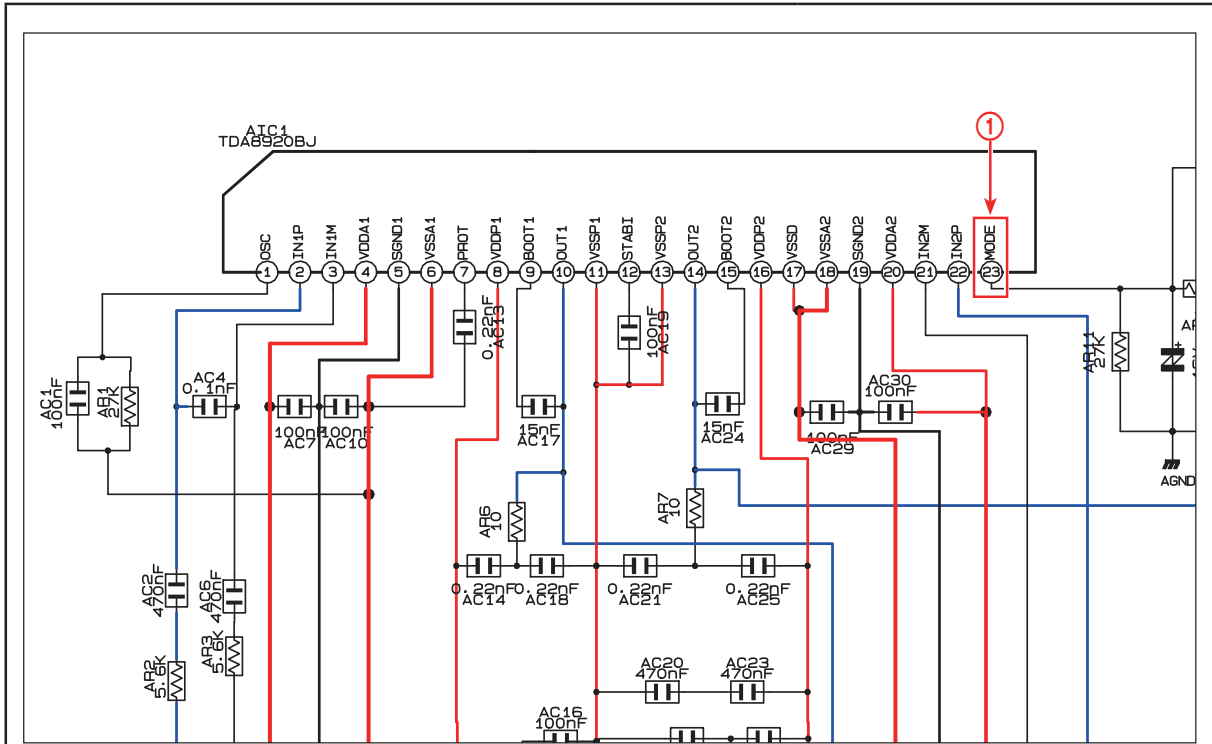

※ MAIN, page 7-5

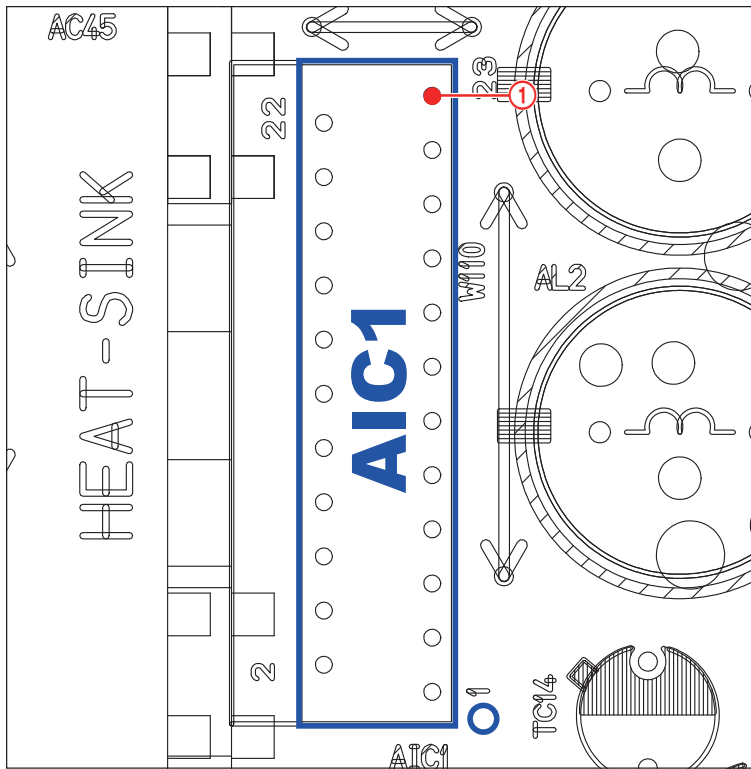

※ MAIN PCB Top, page 6-9

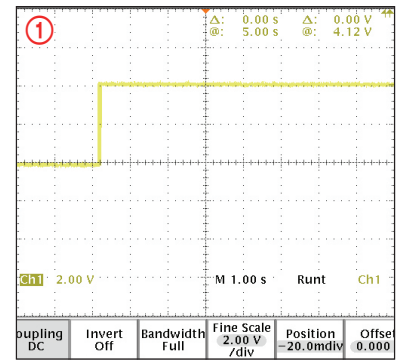

<Fig. 4-3-1>

4-1-3 CD/DVD PACK

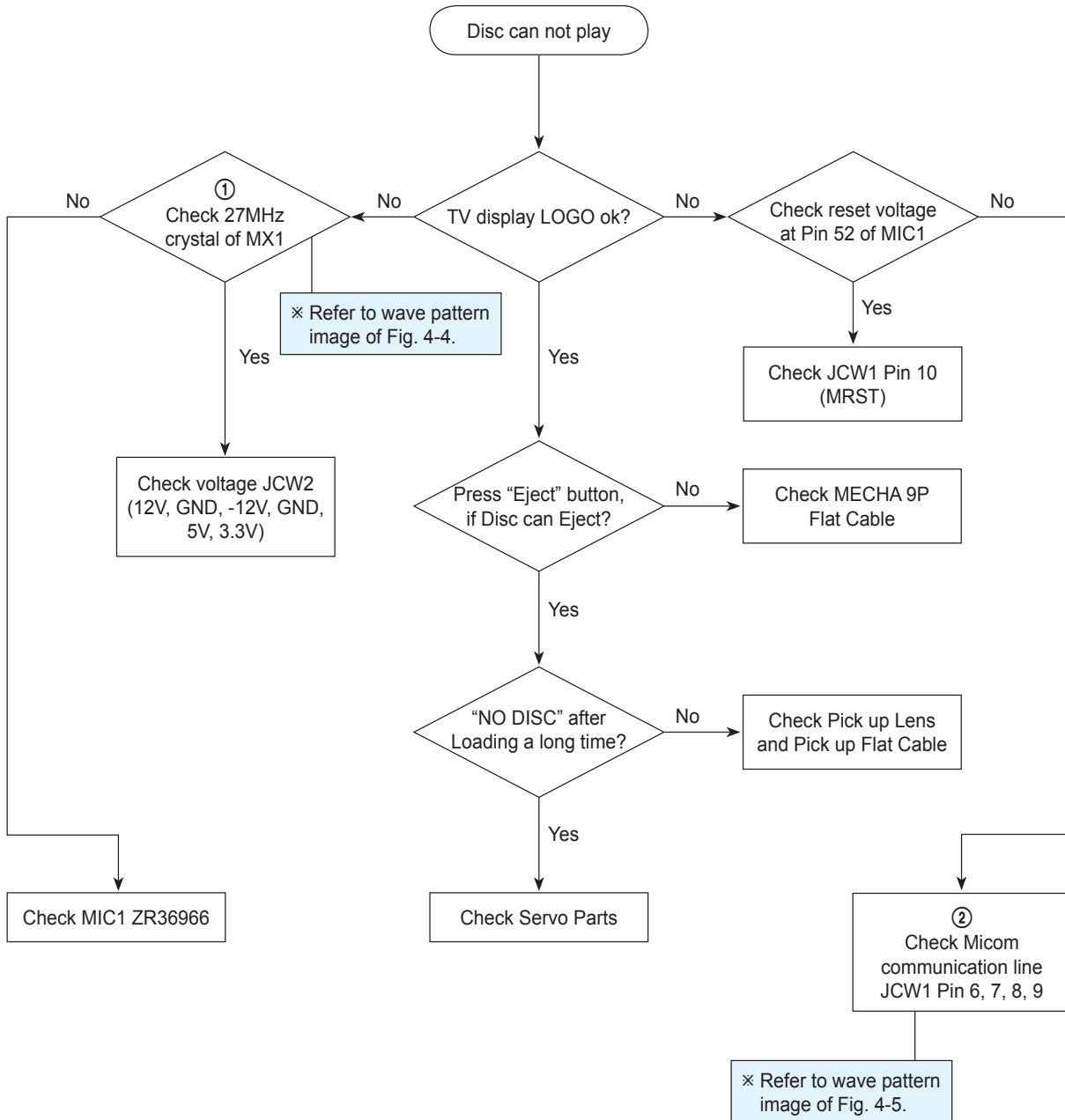

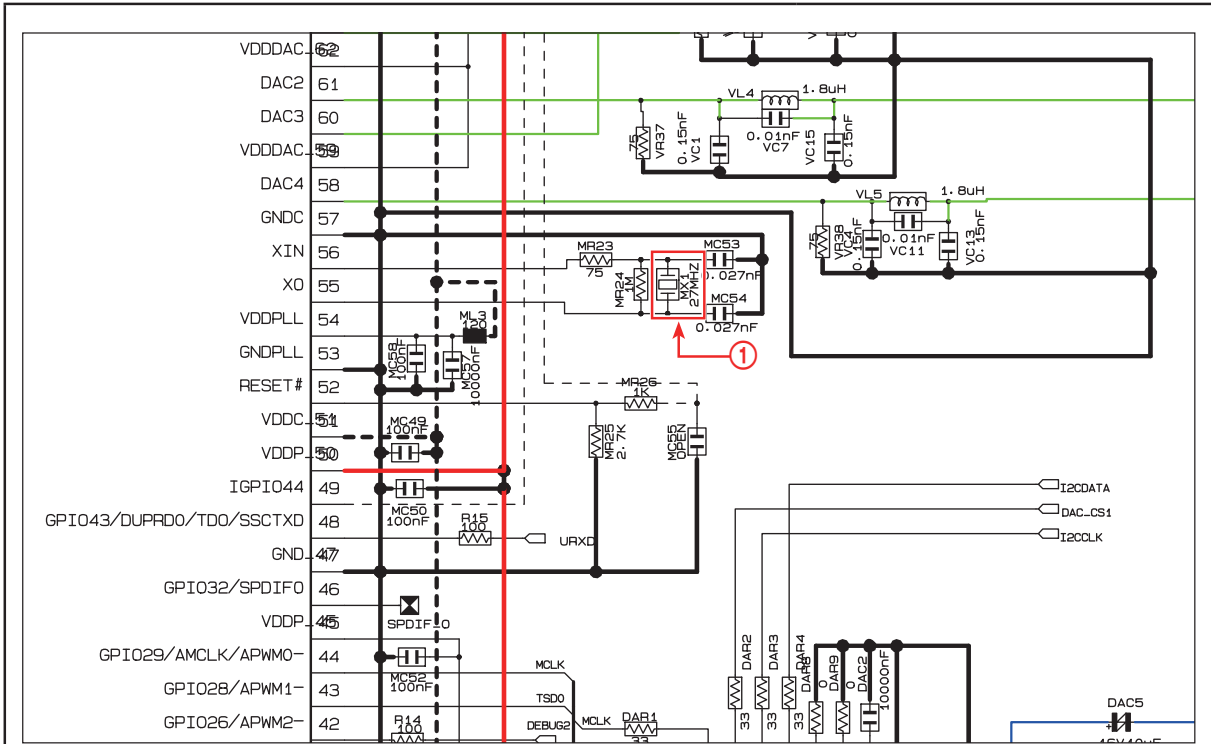

× MPEG, page 7-6

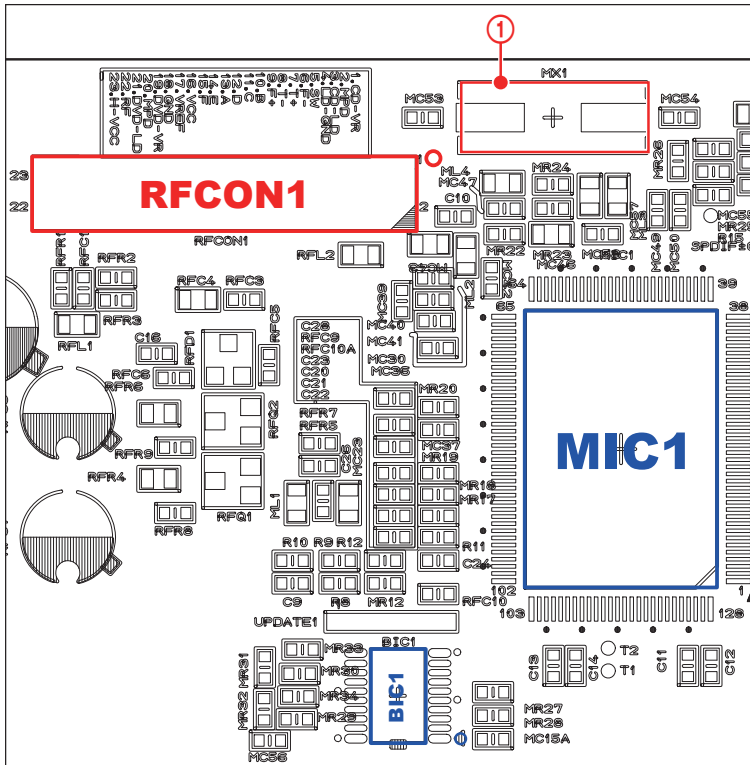

× MPEG PCB Top, page 6-14

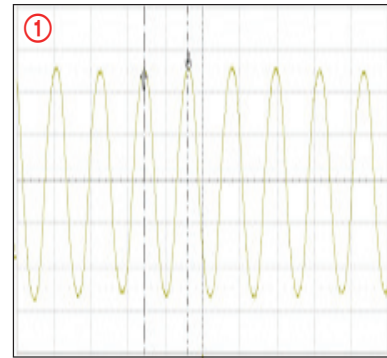

<Fig. 4-4>

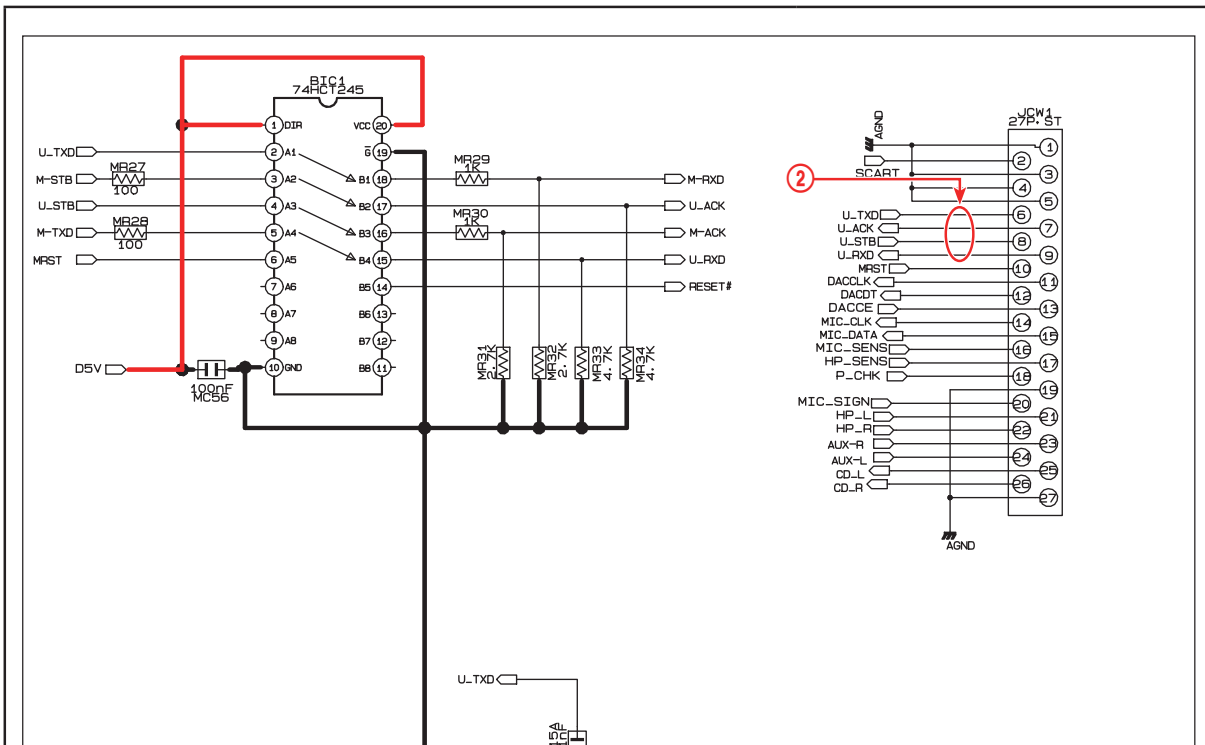

※ MPEG, page 7-6

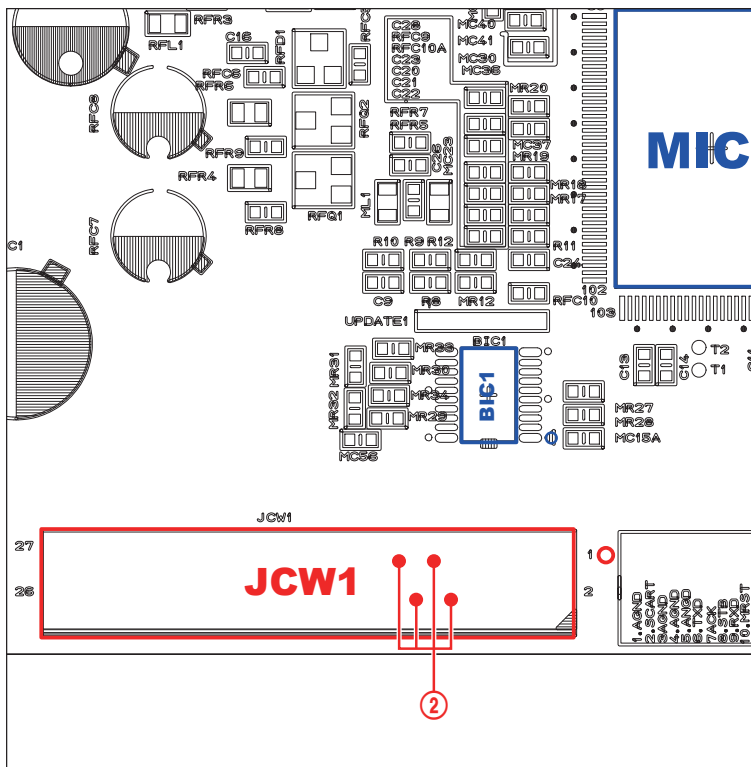

※ MPEG PCB Top, page 6-14

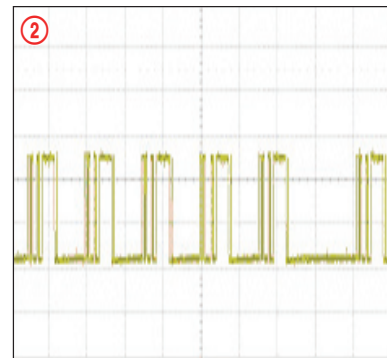

<Fig. 4-5>

4-2 MICOM, MPEG Initialization & Update

■ MICOM Initial

In STANDBY condition, press "STOP" button of Main Unit 5 seconds more, time display as '---:--'. Then Initialization complete.

■ MICOM Update

MICOM update is enabled via USB and CD/DVD.

1. Copy MICOM update file to CD/DVD/USB.
2. File name is "micom.ssp", "update.ver".
3. DVD Model: Osd shows update screen. You have to make sure your update file is most recently version.
Then press "ENTER" to proceed.
CD Model: VFD shows "reading". And "update" shows up and blinking. Wait until MAIN set automatically power off.

■ MPEG Update

1. Copy MPEG update file to CD/DVD/USB.
2. File name is "DGTCXXXW.bin"
3. DVD Model: Osd shows update screen. You have to make sure your update file is most recently version.
Then press "ENTER" to proceed.
CD Model: VFD shows "reading". And "update" shows up and blinking. Wait until MAIN set automatically power off.

4-3 Buyer-Region Code Setting Method

4-3-1 The inserting method of Region Code after replacing the Main PBA

[Reference]

- When replacing the Main PBA and System Micom should be inserted the region code.
- The set is not working properly if you don't insert the region code.
- The region code is inserted by the remote control.

1. Press the "AUX" button on the remote control.

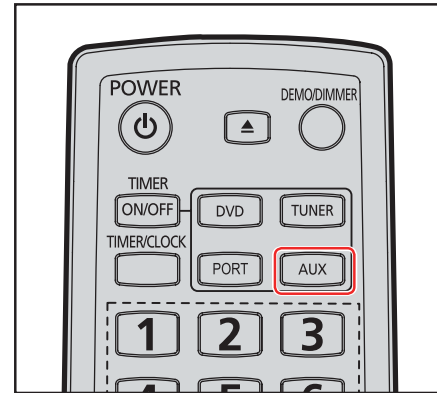

2. Press the "TUNER MEMORY" button on the remote control during 4~5 seconds.

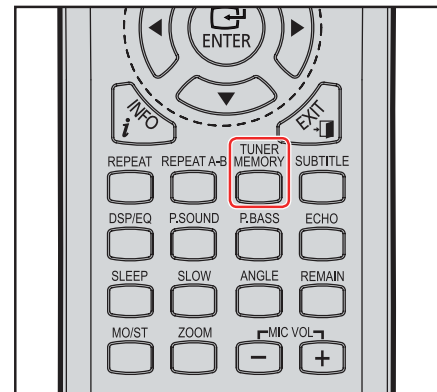

3. After step (2), you can see "TEST --" on the VFD. Insert number "3", "3" to select Region Code.



4. After step (3), you can see "--" on the VFD. Insert the Region Code corresponding model with "0 ~ 9" buttons on the remote control.



5. Turn the Power off.

※ Option Table-1

Area	MM-G25 Region Code	Remark
Africa	00	
Brazil	01	
Middle Asia	02	
China (semi_mic)	03	
Europe	04	
Asia	05	
Britain	06	
Korea	07	
Latin American	08	
Mexico	09	
Philippines	10	
Russia (full_mic)	11	
Russia (semi_mic)	12	
Iran	13	
South Africa	14	
India	15	
Australia	16	
USA / Canada	17	

<Table 4-1>

※ Option Table-2

Area	MM-DG25 Region Code	Remark
Africa	18	
Brazil	19	
Middle Asia	20	
China (semi_mic)	21	
Europe	22	
Asia	23	Thailand
Britain	24	
Korea	25	
Latin American	26	
Mexico	27	
Philippines	28	
Russia (full_mic)	29	Full karaoke models which support midi file.
Russia (semi_mic)	30	Only models which supporting semi-karaoke not including midi file.
Iran	31	Malaysia
South Africa	32	
India	33	
Australia	34	
USA / Canada	35	

<Table 4-2>